

STATE OF NORTH CAROLINA  
**DEPARTMENT OF TRANSPORTATION**

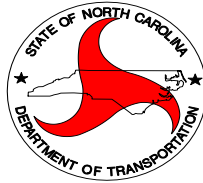

Division 14

District 3

## **Contract & Bonds**

**CONTRACT:** DN00765  
**TIP Number:** HA-0004  
**FEDERAL:** 0441017  
**WBS Element:** 49761.3.1  
**LOCATION:** US 441 / SR 1515 (HYATT RD) INTERSECTION  
**COUNTY:** MACON  
**DESCRIPTION:** GRADING, PAVING, DRAINAGE, SIGNALS AT US 441 / SR 1515 (HYATT RD) INTERSECTION

**Contractor:** Bryson Enterprises LTD, dba Bryson Grading & Paving  
**Address:** PO Box 1691  
Highlands, NC 28741

**Division Engineer:** Wanda Austin, P.E.  
**District Engineer:** J. A. Russell, P.E.  
**Resident Engineer:** Adam Dockery, P.E.

**Letting Date:** 2/22/2022

**Contract Execution:** 04/19/2022

STATE OF NORTH CAROLINA  
DEPARTMENT OF TRANSPORTATION  
HIGHWAY DIVISION 14

## PROPOSAL

DATE AND TIME OF BID OPENING: FEBRUARY 22, 2022 AT 2:00 PM

CONTRACT ID: DN00765

WBS ELEMENT NO.: 49761.3.1

FEDERAL AID NO.: 0441017

COUNTY: MACON

TIP NO.: HA-0004

MILES: 0.5

ROUTE NO.: US 441

LOCATION: US 441 / SR 1515 (HYATT RD) INTERSECTION

TYPE OF WORK: GRADING, PAVING, DRAINAGE, SIGNALS

### NOTICE:

ALL BIDDERS SHALL COMPLY WITH ALL APPLICABLE LAWS REGULATING THE PRACTICE OF GENERAL CONTRACTING AS CONTAINED IN CHAPTER 87 OF THE GENERAL STATUTES OF NORTH CAROLINA WHICH REQUIRES THE BIDDER TO BE LICENSED BY THE N.C. LICENSING BOARD FOR CONTRACTORS WHEN BIDDING ON ANY NON-FEDERAL AID PROJECT WHERE THE BID IS \$30,000 OR MORE, EXCEPT FOR CERTAIN SPECIALTY WORK AS DETERMINED BY THE LICENSING BOARD. BIDDERS SHALL ALSO COMPLY WITH ALL OTHER APPLICABLE LAWS REGULATING THE PRACTICES OF ELECTRICAL, PLUMBING, HEATING AND AIR CONDITIONING AND REFRIGERATION CONTRACTING AS CONTAINED IN CHAPTER 87 OF THE GENERAL STATUTES OF NORTH CAROLINA. NOTWITHSTANDING THESE LIMITATIONS ON BIDDING, THE BIDDER WHO IS AWARDED ANY FEDERAL - AID FUNDED PROJECT SHALL COMPLY WITH CHAPTER 87 OF THE GENERAL STATUTES OF NORTH CAROLINA FOR LICENSING REQUIREMENTS WITHIN 60 CALENDAR DAYS OF BID OPENING.

THIS IS A ROADWAY PROJECT.

BID BOND IS REQUIRED.

Bryson Enterprises LTD, dba Bryson Grading & Paving

---

NAME OF BIDDER

PO Box 1691, Highlands, NC 28741

---

ADDRESS OF BIDDER

**PROPOSAL FOR THE CONSTRUCTION OF**  
**CONTRACT No. DN00765 IN MACON COUNTY, NORTH CAROLINA**  
**Date** 04/19/2022 **20** \_\_\_\_\_  
**DEPARTMENT OF TRANSPORTATION,**  
**RALEIGH, NORTH CAROLINA**

The Bidder has carefully examined the location of the proposed work to be known as Contract No. **DN00765**; has carefully examined the plans and specifications, which are acknowledged to be part of the proposal, the special provisions, the proposal, the form of contract, and the forms of contract payment bond and contract performance bond; and thoroughly understands the stipulations, requirements and provisions. The undersigned bidder agrees to bound upon his execution of the bid and subsequent award to him by the Department of Transportation in accordance with this proposal to provide the necessary contract payment bond and contract performance bond within fourteen days after the written notice of award is received by him. The undersigned Bidder further agrees to provide all necessary machinery, tools, labor, and other means of construction; and to do all the work and to furnish all materials, except as otherwise noted, necessary to perform and complete the said contract in accordance with *the 2018 Standard Specifications for Roads and Structures* by the dates(s) specified in the Project Special Provisions and in accordance with the requirements of the Engineer, and at the unit or lump sum prices, as the case may be, for the various items given on the sheets contained herein.

The Bidder shall provide and furnish all the materials, machinery, implements, appliances and tools, and perform the work and required labor to construct and complete State Highway Contract No. **DN00765** in **Macon County**, for the unit or lump sum prices, as the case may be, bid by the Bidder in his bid and according to the proposal, plans, and specifications prepared by said Department, which proposal, plans, and specifications show the details covering this project, and hereby become a part of this contract.

The published volume entitled *North Carolina Department of Transportation, Raleigh, Standard Specifications for Roads and Structures, January 2018* with all amendments and supplements thereto, is by reference incorporated into and made a part of this contract; that, except as herein modified, all the construction and work included in this contract is to be done in accordance with the specifications contained in said volume, and amendments and supplements thereto, under the direction of the Engineer.

If the proposal is accepted and the award is made, the contract is valid only when signed either by the Contract Officer or such other person as may be designated by the Secretary to sign for the Department of Transportation. The conditions and provisions herein cannot be changed except over the signature of the said Contract Officer or Division Engineer.

The quantities shown in the itemized proposal for the project are considered to be approximate only and are given as the basis for comparison of bids. The Department of Transportation may increase or decrease the quantity of any item or portion of the work as may be deemed necessary or expedient.

An increase or decrease in the quantity of an item will not be regarded as sufficient ground for an increase or decrease in the unit prices, nor in the time allowed for the completion of the work, except as provided for the contract.

Accompanying this bid is a bid bond secured by a corporate surety, or certified check payable to the order of the Department of Transportation, for five percent of the total bid price, which deposit is to be forfeited as liquidated damages in case this bid is accepted and the Bidder shall fail to provide the required payment and performance bonds with the Department of Transportation, under the condition of this proposal, within 14 calendar days after the written notice of award is received by him, as provided in the Standard Specifications; otherwise said deposit will be returned to the Bidder.



Division 14 Project Team Lead

DocuSigned by:

*Joshua B. Depton*

CF757BC4CC1041E...

TABLE OF CONTENTS

**COVER SHEET  
PROPOSAL SHEET**

THIS CONTRACT IS FOR TIP **HA-0004** CONTRACT ID **DN00765** FOR **GRADING, PAVING, DRAINAGE, SIGNALS** TYPE OF WORK AT **US 441 / SR 1515 (HYATT RD) INTERSECTION** IN **MACON COUNTY**.

**SPECIAL PROVISIONS**

DIVISION LET CONTRACT PREQUALIFICATION ..... 5

BOND REQUIREMENTS: ..... 5

CONTRACT TIME AND LIQUIDATED DAMAGES: ..... 5

INTERMEDIATE CONTRACT TIME NUMBER 1 AND LIQUIDATED DAMAGES: ..... 5

INTERMEDIATE CONTRACT TIME NUMBER 2 AND LIQUIDATED DAMAGES: ..... 6

PERMANENT VEGETATION ESTABLISHMENT: ..... 7

NO MAJOR CONTRACT ITEMS: ..... 8

NO SPECIALTY ITEMS: ..... 8

FUEL PRICE ADJUSTMENT: ..... 8

SCHEDULE OF ESTIMATED COMPLETION PROGRESS: ..... 9

DISADVANTAGED BUSINESS ENTERPRISE (DIVISIONS): ..... 9

CERTIFICATION FOR FEDERAL-AID CONTRACTS: ..... 21

CONTRACTOR'S LICENSE REQUIREMENTS: ..... 22

RESTRICTIONS ON ITS EQUIPMENT AND SERVICES: ..... 22

USE OF UNMANNED AIRCRAFT SYSTEM (UAS): ..... 22

EQUIPMENT IDLING GUIDELINES: ..... 23

U.S. DEPARTMENT OF TRANSPORTATION HOTLINE: ..... 23

CARGO PREFERENCE ACT: ..... 24

ELECTRONIC BIDDING: ..... 24

AWARD LIMITS: ..... 25

TWELVE MONTH GUARANTEE: ..... 25

EROSION AND SEDIMENT CONTROL/STORMWATER CERTIFICATION: ..... 26

PROCEDURE FOR MONITORING BORROW PIT DISCHARGE: ..... 30

ROADWAY ..... 32

AVAILABILITY OF FUNDS – TERMINATION OF CONTRACTS ..... 55

NCDOT GENERAL SEED SPECIFICATION FOR SEED QUALITY ..... 56

ERRATA ..... 59

PLANT AND PEST QUARANTINES ..... 61

TITLE VI AND NONDISCRIMINATION: ..... 62

MINORITY AND FEMALE EMPLOYMENT REQUIREMENTS ..... 69

REQUIRED CONTRACT PROVISIONS FEDERAL - AID CONSTRUCTION  
CONTRACTS ..... 72

ON-THE-JOB TRAINING ..... 81

MINIMUM WAGES ..... 84

EROSION CONTROL ..... EC

TRAFFIC SIGNALS ..... TS

**PROPOSAL ITEM SHEET AND SIGNATURE SHEET**

ITEM SHEET(S).....T-1  
SIGNATURE SHEETS...S-1  
EXECUTION SHEET .....U-1

**INSTRUCTIONS TO BIDDERS**

**PLEASE READ ALL INSTRUCTIONS CAREFULLY  
BEFORE PREPARING AND SUBMITTING YOUR BID.**

**All bids shall be prepared and submitted in accordance with the following requirements. Failure to comply with any requirement may cause the bid to be considered irregular and may be grounds for rejection of the bid.**

For preparing and submitting the bid electronically, refer to Article 102-8(B) of the *2018 Standard Specifications*.

Bidders that bid electronically on Raleigh Central-Let projects will need a separate Digital Signature from the approved electronic bidding provider for Division Contracts.

**ELECTRONIC ON-LINE BID:**

1. Download entire proposal from Connect NCDOT website. Download the electronic submittal file from the approved electronic bidding provider website.
2. Prepare and submit the electronic submittal file using the approved electronic bidding provider software.
3. Electronic bidding software necessary for electronic bid preparation may be downloaded from the Connect NCDOT website at: <https://connect.ncdot.gov/letting/Pages/Electronic-Bidding.aspx> or from the approved electronic bidding provider website.

**PROJECT SPECIAL PROVISIONS****GENERAL****DIVISION LET CONTRACT PREQUALIFICATION:**

(07-01-14)(12-1-16)

SPD 01-410

Any firm that wishes to bid as a prime contractor shall be prequalified as a Bidder or PO Prime Contractor prior to submitting a bid. Information regarding prequalification can be found at: <https://connect.ncdot.gov/business/Prequal/Pages/default.aspx>.

Prior to performing the work, the prime contractor and/or subcontractor(s) shall be prequalified in the work code(s) which are identified as work items in the prime contractor's construction progress schedule that they will complete themselves. Any contractor identified as working outside their expertise may be considered in default of contract.

**BOND REQUIREMENTS:**

(06-01-16)

102-8, 102-10

SPD 01-420A

A Bid Bond is required in accordance with Article 102-10 of the *2018 Standard Specifications for Roads and Structures*.

Contract Payment and Performance Bonds are required in accordance with Article 103-7 of the *2018 Standard Specifications for Roads and Structures*.

**CONTRACT TIME AND LIQUIDATED DAMAGES:**

(4-17-12)

108

SP1 G07 C

The date of availability for this contract is **March 21, 2022**.

The completion date for this contract is **April 16, 2023**.

Except where otherwise provided by the contract, observation periods required by the contract will not be a part of the work to be completed by the completion date and/or intermediate contract times stated in the contract. The acceptable completion of the observation periods that extend beyond the final completion date shall be a part of the work covered by the performance and payment bonds.

The liquidated damages for this contract are **Two Hundred Dollars (\$ 200.00)** per calendar day. These liquidated damages will not be cumulative with any liquidated damages which may become chargeable under Intermediate Contract Time Number 1.

**INTERMEDIATE CONTRACT TIME NUMBER 1 AND LIQUIDATED DAMAGES:**

(7-1-95) (Rev. 2-21-12)

108

SP1 G13 A

Except for that work required under the Project Special Provisions entitled *Planting, Reforestation* and/or *Permanent Vegetation Establishment*, **and except for work required under ICT 3**, included elsewhere in this proposal, the Contractor will be required to complete all work included in this contract and shall place and maintain traffic on same.

The date of availability for this intermediate contract time is **March 21, 2022**.

The completion date for this intermediate contract time is **June 23, 2022**.

The liquidated damages for this intermediate contract time are **Eight Hundred Fifty Dollars (\$ 850.00)** per calendar day.

Upon apparent completion of all the work required to be completed by this intermediate date, a final inspection will be held in accordance with Article 105-17 and upon acceptance, the Department will assume responsibility for the maintenance of all work except *Planting, Reforestation* and/or *Permanent Vegetation Establishment*. The Contractor will be responsible for and shall make corrections of all damages to the completed roadway caused by his planting operations, whether occurring prior to or after placing traffic through the project.

**INTERMEDIATE CONTRACT TIME NUMBER 2 AND LIQUIDATED DAMAGES:**

(2-20-07)

108

SP1 G14 A

The Contractor shall complete the required work of installing, maintaining, and removing the traffic control devices for lane closures and restoring traffic to the existing traffic pattern. The Contractor shall not close or narrow a lane of traffic on **US 441 / SR 1515 (HYATT RD)** during the following time restrictions:

**DAY AND TIME RESTRICTIONS**

**MONDAY – FRIDAY  
7:00 AM - 8:00 AM  
AND  
5:00 PM - 6:00 PM**

In addition, the Contractor shall not close or narrow a lane of traffic on **US 441 / SR 1515 (HYATT RD)**, detain and/or alter the traffic flow on or during holidays, holiday weekends, special events, or any other time when traffic is unusually heavy, including the following schedules:

**HOLIDAY AND HOLIDAY WEEKEND LANE CLOSURE RESTRICTIONS**

1. For **unexpected occurrence** that creates unusually high traffic volumes, as directed by the Engineer.
2. For **New Year's Day**, between the hours of **4:00 PM** December 31st and **7:00 AM** January 2nd. If New Year's Day is on a Friday, Saturday, Sunday or Monday, then until **7:00 AM** the following Tuesday.
3. For **Easter**, between the hours of **4:00 PM** Thursday and **7:00 AM** Monday.
4. For **Memorial Day**, between the hours of **4:00 PM** Friday and **7:00 AM** Tuesday.
5. For **Independence Day**, between the hours of **4:00 PM** the day before Independence Day and **7:00 AM** the day after Independence Day.  
  
If **Independence Day** is on a Friday, Saturday, Sunday or Monday, then between the hours of **4:00 PM** the Thursday before Independence Day and **7:00 AM** the Tuesday after Independence Day.
6. For **Labor Day**, between the hours of **4:00 PM** Friday and **7:00 AM** Tuesday.
7. For **Thanksgiving Day**, between the hours of **4:00 PM** Tuesday and **7:00 AM** Monday.



8. For **Christmas**, between the hours of **4:00 PM** the Friday before the week of Christmas Day and **7:00 AM** the following Tuesday after the week of Christmas Day.

Holidays and holiday weekends shall include New Year's, Easter, Memorial Day, Independence Day, Labor Day, Thanksgiving, and Christmas. The Contractor shall schedule his work so that lane closures will not be required during these periods, unless otherwise directed by the Engineer.

The time of availability for this intermediate contract work shall be the time the Contractor begins to install all traffic control devices for lane closures according to the time restrictions listed herein.

The completion time for this intermediate contract work shall be the time the Contractor is required to complete the removal of all traffic control devices for lane closures according to the time restrictions stated above and place traffic in the existing traffic pattern.

The liquidated damages are **Two Hundred Fifty Dollars (\$ 250.00)** per hour.

**INTERMEDIATE CONTRACT TIME NUMBER 3 AND LIQUIDATED DAMAGES:**

(6-18-13)

108

SP1 G14 L

The Contractor shall complete the work required of **Permanent Signal System** as shown on Sheet(s) **SIG.1.1 THRU SIG.2.2** and shall place and maintain traffic on same.

The date of availability for this intermediate contract time is **October 3, 2022**.

The completion date for this intermediate contract time is **October 17, 2022**.

The liquidated damages are **Eight Hundred Fifty Dollars (\$ 850.00)** per calendar day.

**PERMANENT VEGETATION ESTABLISHMENT:**

(2-16-12) (Rev. 10-15-13)

104

SP1 G16

Establish a permanent stand of the vegetation mixture shown in the contract. During the period between initial vegetation planting and final project acceptance, perform all work necessary to establish permanent vegetation on all erodible areas within the project limits, as well as, in borrow and waste pits. This work shall include erosion control device maintenance and installation, repair seeding and mulching, supplemental seeding and mulching, mowing, and fertilizer topdressing, as directed. All work shall be performed in accordance with the applicable section of the *2018 Standard Specifications*. All work required for initial vegetation planting shall be performed as a part of the work necessary for the completion and acceptance of the Intermediate Contract Time (ICT). Between the time of ICT and Final Project acceptance, or otherwise referred to as the vegetation establishment period, the Department will be responsible for preparing the required National Pollutant Discharge Elimination System (NPDES) inspection records.

Once the Engineer has determined that the permanent vegetation establishment requirement has been achieved at an 80% vegetation density (the amount of established vegetation per given area to stabilize the soil) and no erodible areas exist within the project limits, the Contractor will be notified to remove the remaining erosion control devices that are no longer needed. The Contractor will be responsible for, and shall correct any areas disturbed by operations performed in permanent vegetation establishment and the removal of temporary erosion control measures, whether occurring prior to or after placing traffic on the project.

Payment for *Response for Erosion Control, Seeding and Mulching, Repair Seeding, Supplemental Seeding, Mowing, Fertilizer Topdressing, Silt Excavation, and Stone for Erosion Control* will be made at contract unit prices for the affected items. Work required that is not represented by contract line items will be paid in accordance with Articles 104-7 or 104-3 of the *2018 Standard Specifications*. No additional compensation will be made for maintenance and removal of temporary erosion control items.

**NO MAJOR CONTRACT ITEMS:**

(2-19-02) (Rev. 8-21-07)

104

SP1 G31

None of the items included in this contract will be major items.

**NO SPECIALTY ITEMS:**

(7-1-95)

108-6

SP1 G34

None of the items included in this contract will be specialty items (see Article 108-6 of the *2018 Standard Specifications*).

**FUEL PRICE ADJUSTMENT:**

(11-15-05) (Rev. 7-20-21)

109-8

SP1 G43

Revise the *2018 Standard Specifications* as follows:

**Page 1-87, Article 109-8, Fuel Price Adjustments**, add the following:

The base index price for DIESEL #2 FUEL is **\$ 2.6786** per gallon. Where any of the following are included as pay items in the contract, they will be eligible for fuel price adjustment.

The pay items and the fuel factor used in calculating adjustments to be made will be as follows:

Description	Units	Fuel Usage Factor Diesel
Unclassified Excavation	Gal/CY	0.29
Borrow Excavation	Gal/CY	0.29
Class IV Subgrade Stabilization	Gal/Ton	0.55
Aggregate Base Course	Gal/Ton	0.55
Sub-Ballast	Gal/Ton	0.55
Asphalt Concrete Base Course, Type ____	Gal/Ton	0.90 or 2.90
Asphalt Concrete Intermediate Course, Type ____	Gal/Ton	0.90 or 2.90
Asphalt Concrete Surface Course, Type ____	Gal/Ton	0.90 or 2.90
Open-Graded Asphalt Friction Course	Gal/Ton	0.90 or 2.90
Permeable Asphalt Drainage Course, Type ____	Gal/Ton	0.90 or 2.90
Sand Asphalt Surface Course, Type ____	Gal/Ton	0.90 or 2.90
Aggregate for Cement Treated Base Course	Gal/Ton	0.55
Portland Cement for Cement Treated Base Course	Gal/Ton	0.55
__" Portland Cement Concrete Pavement	Gal/SY	0.245
Concrete Shoulders Adjacent to __" Pavement	Gal/SY	0.245

For the asphalt items noted in the chart as eligible for fuel adjustments, the bidder may include the *Fuel Usage Factor Adjustment Form* with their bid submission if they elect to use the fuel usage factor. The *Fuel Usage Factor Adjustment Form* is found at the following link:

<https://connect.ncdot.gov/letting/LetCentral/Fuel%20Usage%20Factor%20Adjustment%20Form.pdf>

Select either 2.90 Gal/Ton fuel factor or 0.90 Gal/Ton fuel factor for each asphalt line item on the *Fuel Usage Factor Adjustment Form*. The selected fuel factor for each asphalt item will remain in effect for the duration of the contract.

Failure to complete the *Fuel Usage Factor Adjustment Form* will result in using 2.90 gallons per ton as the Fuel Usage Factor for Diesel for the asphalt items noted above. The contractor will not be permitted to change the Fuel Usage Factor after the bids are submitted.

**SCHEDULE OF ESTIMATED COMPLETION PROGRESS:**

(7-15-08) (Rev. 5-13-19)

108-2

SP1 G58

The Contractor's attention is directed to the Standard Special Provision entitled *Availability of Funds Termination of Contracts* included elsewhere in this proposal. The Department of Transportation's schedule of estimated completion progress for this project as required by that Standard Special Provision is as follows:

	<b><u>Fiscal Year</u></b>	<b><u>Progress (% of Dollar Value)</u></b>
2022	(7/01/21 - 6/30/22)	<b>95%</b> of Total Amount Bid
2023	(7/01/22 - 6/30/23)	<b>5%</b> of Total Amount Bid

The Contractor shall also furnish his own progress schedule in accordance with Article 108-2 of the *2018 Standard Specifications*. Any acceleration of the progress as shown by the Contractor's progress schedule over the progress as shown above shall be subject to the approval of the Engineer.

**DISADVANTAGED BUSINESS ENTERPRISE (DIVISIONS):**

(10-16-07)(Rev. 8-17-21)

102-15(J)

SP1 G62

**Description**

The purpose of this Special Provision is to carry out the U.S. Department of Transportation's policy of ensuring nondiscrimination in the award and administration of contracts financed in whole or in part with Federal funds. This provision is guided by 49 CFR Part 26.

**Definitions**

*Additional DBE Subcontractors* - Any DBE submitted at the time of bid that will not be used to meet the DBE goal. No submittal of a Letter of Intent is required.

*Committed DBE Subcontractor* - Any DBE submitted at the time of bid that is being used to meet the DBE goal by submission of a Letter of Intent. Or any DBE used as a replacement for a previously committed DBE firm.

*Contract Goal Requirement* - The approved DBE participation at time of award, but not greater than the advertised contract goal.

*DBE Goal* - A portion of the total contract, expressed as a percentage, that is to be performed by committed DBE subcontractor(s).

*Disadvantaged Business Enterprise (DBE)* - A firm certified as a Disadvantaged Business Enterprise through the North Carolina Unified Certification Program.

*Goal Confirmation Letter* - Written documentation from the Department to the bidder confirming the Contractor's approved, committed DBE participation along with a listing of the committed DBE firms.

*Manufacturer* - A firm that operates or maintains a factory or establishment that produces on the premises, the materials or supplies obtained by the Contractor.

*Regular Dealer* - A firm that owns, operates, or maintains a store, warehouse, or other establishment in which the materials or supplies required for the performance of the contract are bought, kept in stock, and regularly sold to the public in the usual course of business. A regular dealer engages in, as its principal business and in its own name, the purchase and sale or lease of the products in question. A regular dealer in such bulk items as steel, cement, gravel, stone, and petroleum products need not keep such products in stock, if it owns and operates distribution equipment for the products. Brokers and packagers are not regarded as manufacturers or regular dealers within the meaning of this section.

*Replacement / Substitution* – A full or partial reduction in the amount of work subcontracted to a committed (or an approved substitute) DBE firm.

*North Carolina Unified Certification Program (NCUCP)* - A program that provides comprehensive services and information to applicants for DBE certification, such that an applicant is required to apply only once for a DBE certification that will be honored by all recipients of USDOT funds in the state and not limited to the Department of Transportation only. The Certification Program is in accordance with 49 CFR Part 26.

*United States Department of Transportation (USDOT)* - Federal agency responsible for issuing regulations (49 CFR Part 26) and official guidance for the DBE program.

### **Forms and Websites Referenced in this Provision**

*DBE Payment Tracking System* - On-line system in which the Contractor enters the payments made to DBE subcontractors who have performed work on the project.  
<https://apps.dot.state.nc.us/Vendor/PaymentTracking/>

*DBE-IS Subcontractor Payment Information* - Form for reporting the payments made to all DBE firms working on the project. This form is for paper bid projects only.  
<https://connect.ncdot.gov/business/Turnpike/Documents/Form%20DBE-IS%20Subcontractor%20Payment%20Information.pdf>

*RF-1 DBE Replacement Request Form* - Form for replacing a committed DBE.  
<http://connect.ncdot.gov/projects/construction/Construction%20Forms/DBE%20MBE%20WBE%20Replacement%20Request%20Form.pdf>

*SAF Subcontract Approval Form* - Form required for approval to sublet the contract.  
<http://connect.ncdot.gov/projects/construction/Construction%20Forms/Subcontract%20Approval%20Form%20Rev.%202012.zip>

*JC-1 Joint Check Notification Form* - Form and procedures for joint check notification. The form acts as a written joint check agreement among the parties providing full and prompt disclosure of the expected use of joint checks.

<http://connect.ncdot.gov/projects/construction/Construction%20Forms/Joint%20Check%20Notification%20Form.pdf>

*Letter of Intent* - Form signed by the Contractor and the DBE subcontractor, manufacturer or regular dealer that affirms that a portion of said contract is going to be performed by the signed DBE for the estimated amount (based on quantities and unit prices) listed at the time of bid.

<http://connect.ncdot.gov/letting/LetCentral/Letter%20of%20Intent%20to%20Perform%20as%20a%20Subcontractor.pdf>

*Listing of DBE Subcontractors Form* - Form for entering DBE subcontractors on a project that will meet this DBE goal. This form is for paper bids only.

[http://connect.ncdot.gov/municipalities/Bid%20Proposals%20for%20LGA%20Content/08%20DBE%20Subcontractors%20\(Federal\).docx](http://connect.ncdot.gov/municipalities/Bid%20Proposals%20for%20LGA%20Content/08%20DBE%20Subcontractors%20(Federal).docx)

*Subcontractor Quote Comparison Sheet* - Spreadsheet for showing all subcontractor quotes in the work areas where DBEs quoted on the project. This sheet is submitted with good faith effort packages.

<http://connect.ncdot.gov/business/SmallBusiness/Documents/DBE%20Subcontractor%20Quote%20Comparison%20Example.xls>

### **DBE Goal**

The following DBE goal for participation by Disadvantaged Business Enterprises is established for this contract:

Disadvantaged Business Enterprises **5.0** %

- (A) *If the DBE goal is more than zero*, the Contractor shall exercise all necessary and reasonable steps to ensure that DBEs participate in at least the percent of the contract as set forth above as the DBE goal.
- (B) *If the DBE goal is zero*, the Contractor shall make an effort to recruit and use DBEs during the performance of the contract. Any DBE participation obtained shall be reported to the Department.

### **Directory of Transportation Firms (Directory)**

Real-time information is available about firms doing business with the Department and firms that are certified through NCUCP in the Directory of Transportation Firms. Only firms identified in the Directory as DBE certified shall be used to meet the DBE goal. The Directory can be found at the following link.  
[https:// www.ebs.nc.gov/VendorDirectory/default.html](https://www.ebs.nc.gov/VendorDirectory/default.html)

The listing of an individual firm in the directory shall not be construed as an endorsement of the firm's capability to perform certain work.

### **Listing of DBE Subcontractors**

At the time of bid, bidders shall submit all DBE participation that they anticipate to use during the life of the contract. Only those identified to meet the DBE goal will be considered committed, even though the listing shall include both committed DBE subcontractors and additional DBE subcontractors. Additional DBE subcontractor participation submitted at the time of bid will be used toward the Department's overall race-neutral goal. Only those firms with current DBE certification at the time of bid opening will be

acceptable for listing in the bidder's submittal of DBE participation. The Contractor shall indicate the following required information:

(A) Electronic Bids

Bidders shall submit a listing of DBE participation in the appropriate section of the electronic submittal file.

- (1) Submit the names and addresses of DBE firms identified to participate in the contract. If the bidder uses the updated listing of DBE firms shown in the electronic submittal file, the bidder may use the dropdown menu to access the name and address of the DBE firm.
- (2) Submit the contract line numbers of work to be performed by each DBE firm. When no figures or firms are entered, the bidder will be considered to have no DBE participation.
- (3) The bidder shall be responsible for ensuring that the DBE is certified at the time of bid by checking the Directory of Transportation Firms. If the firm is not certified at the time of the bid-letting, that DBE's participation will not count towards achieving the DBE goal.

(B) Paper Bids

- (1) *If the DBE goal is more than zero,*
  - (a) Bidders, at the time the bid proposal is submitted, shall submit a listing of DBE participation, including the names and addresses on *Listing of DBE Subcontractors* contained elsewhere in the contract documents in order for the bid to be considered responsive. Bidders shall indicate the total dollar value of the DBE participation for the contract.
  - (b) If bidders have no DBE participation, they shall indicate this on the *Listing of DBE Subcontractors* by entering the word "None" or the number "0." This form shall be completed in its entirety. **Blank forms will not be deemed to represent zero participation.** Bids submitted that do not have DBE participation indicated on the appropriate form will not be read publicly during the opening of bids. The Department will not consider these bids for award and the proposal will be rejected.
  - (c) The bidder shall be responsible for ensuring that the DBE is certified at the time of bid by checking the Directory of Transportation Firms. If the firm is not certified at the time of the bid-letting, that DBE's participation will not count towards achieving the DBE goal.
- (2) *If the DBE goal is zero,* entries on the *Listing of DBE Subcontractors* are not required, however any DBE participation that is achieved during the project shall be reported in accordance with requirements contained elsewhere in the special provision.

**DBE Prime Contractor**

When a certified DBE firm bids on a contract that contains a DBE goal, the DBE firm is responsible for meeting the goal or making good faith efforts to meet the goal, just like any other bidder. In most cases, a DBE bidder on a contract will meet the DBE goal by virtue of the work it performs on the contract with its

own forces. However, all the work that is performed by the DBE bidder and any other DBE subcontractors will count toward the DBE goal. The DBE bidder shall list itself along with any DBE subcontractors, if any, in order to receive credit toward the DBE goal.

For example, if the DBE goal is 45% and the DBE bidder will only perform 40% of the contract work, the prime will list itself at 40%, and the additional 5% shall be obtained through additional DBE participation with DBE subcontractors or documented through a good faith effort.

DBE prime contractors shall also follow Sections A or B listed under *Listing of DBE Subcontractor* just as a non-DBE bidder would.

### **Written Documentation – Letter of Intent**

The bidder shall submit written documentation for each DBE that will be used to meet the DBE goal of the contract, indicating the bidder's commitment to use the DBE in the contract. This documentation shall be submitted on the Department's form titled *Letter of Intent*.

The documentation shall be received in the office of the Engineer no later than 2:00 p.m. of the fifth calendar day following opening of bids, unless the fifth day falls on Saturday, Sunday or an official state holiday. In that situation, it is due in the office of the Engineer no later than 10:00 a.m. on the next official state business day.

If the bidder fails to submit the Letter of Intent from each committed DBE to be used toward the DBE goal, or if the form is incomplete (i.e. both signatures are not present), the DBE participation will not count toward meeting the DBE goal. If the lack of this participation drops the commitment below the DBE goal, the Contractor shall submit evidence of good faith efforts, completed in its entirety, to the Engineer no later than 2:00 p.m. on the eighth calendar day following opening of bids, unless the eighth day falls on Saturday, Sunday or an official state holiday. In that situation, it is due in the office of the Engineer no later than 10:00 a.m. on the next official state business day.

### **Submission of Good Faith Effort**

If the bidder fails to meet or exceed the DBE goal the apparent lowest responsive bidder shall submit to the Department documentation of adequate good faith efforts made to reach the DBE goal.

One complete set and 2 copies of this information shall be received in the office of the Engineer no later than 2:00 p.m. of the fifth calendar day following opening of bids, unless the fifth day falls on Saturday, Sunday or an official state holiday. In that situation, it is due in the office of the Engineer no later than 10:00 a.m. on the next official state business day.

Note: Where the information submitted includes repetitious solicitation letters, it will be acceptable to submit a representative letter along with a distribution list of the firms that were solicited. Documentation of DBE quotations shall be a part of the good faith effort submittal. This documentation may include written subcontractor quotations, telephone log notations of verbal quotations, or other types of quotation documentation.

### **Consideration of Good Faith Effort for Projects with DBE Goals More Than Zero**

Adequate good faith efforts mean that the bidder took all necessary and reasonable steps to achieve the goal which, by their scope, intensity, and appropriateness, could reasonably be expected to obtain sufficient DBE

participation. Adequate good faith efforts also mean that the bidder actively and aggressively sought DBE participation. Mere *pro forma* efforts are not considered good faith efforts.

The Department will consider the quality, quantity, and intensity of the different kinds of efforts a bidder has made. Listed below are examples of the types of actions a bidder will take in making a good faith effort to meet the goal and are not intended to be exclusive or exhaustive, nor is it intended to be a mandatory checklist.

- (A) Soliciting through all reasonable and available means (e.g. attendance at pre-bid meetings, advertising, written notices, use of verifiable electronic means through the use of the NCDOT Directory of Transportation Firms) the interest of all certified DBEs who have the capability to perform the work of the contract. The bidder must solicit this interest within at least 10 days prior to bid opening to allow the DBEs to respond to the solicitation. Solicitation shall provide the opportunity to DBEs within the Division and surrounding Divisions where the project is located. The bidder must determine with certainty if the DBEs are interested by taking appropriate steps to follow up initial solicitations.
- (B) Selecting portions of the work to be performed by DBEs in order to increase the likelihood that the DBE goals will be achieved.
  - (1) Where appropriate, break out contract work items into economically feasible units to facilitate DBE participation, even when the prime contractor might otherwise prefer to perform these work items with its own forces.
  - (2) Negotiate with subcontractors to assume part of the responsibility to meet the contract DBE goal when the work to be sublet includes potential for DBE participation (2<sup>nd</sup> and 3<sup>rd</sup> tier subcontractors).
- (C) Providing interested DBEs with adequate information about the plans, specifications, and requirements of the contract in a timely manner to assist them in responding to a solicitation.
- (D)
  - (1) Negotiating in good faith with interested DBEs. It is the bidder's responsibility to make a portion of the work available to DBE subcontractors and suppliers and to select those portions of the work or material needs consistent with the available DBE subcontractors and suppliers, so as to facilitate DBE participation. Evidence of such negotiation includes the names, addresses, and telephone numbers of DBEs that were considered; a description of the information provided regarding the plans and specifications for the work selected for subcontracting; and evidence as to why additional agreements could not be reached for DBEs to perform the work.
  - (2) A bidder using good business judgment would consider a number of factors in negotiating with subcontractors, including DBE subcontractors, and would take a firm's price and capabilities as well as contract goals into consideration. However, the fact that there may be some additional costs involved in finding and using DBEs is not in itself sufficient reason for a bidder's failure to meet the contract DBE goal, as long as such costs are reasonable. Also, the ability or desire of a prime contractor to perform the work of a contract with its own organization does not relieve the bidder of the responsibility to make good faith efforts. Bidding contractors are not, however, required to accept higher quotes from DBEs if the price difference is excessive or unreasonable.



- (E) Not rejecting DBEs as being unqualified without sound reasons based on a thorough investigation of their capabilities. The bidder's standing within its industry, membership in specific groups, organizations, or associates and political or social affiliations (for example, union vs. non-union employee status) are not legitimate causes for the rejection or non-solicitation of bids in the bidder's efforts to meet the project goal.
- (F) Making efforts to assist interested DBEs in obtaining bonding, lines of credit, or insurance as required by the recipient or bidder.
- (G) Making efforts to assist interested DBEs in obtaining necessary equipment, supplies, materials, or related assistance or services.
- (H) Effectively using the services of available minority/women community organizations; minority/women contractors' groups; Federal, State, and local minority/women business assistance offices; and other organizations as allowed on a case-by-case basis to provide assistance in the recruitment and placement of DBEs. Contact within 7 days from the bid opening the Business Opportunity and Work Force Development Unit at BOWD@ncdot.gov to give notification of the bidder's inability to get DBE quotes.
- (I) Any other evidence that the bidder submits which shows that the bidder has made reasonable good faith efforts to meet the DBE goal.

In addition, the Department may take into account the following:

- (1) Whether the bidder's documentation reflects a clear and realistic plan for achieving the DBE goal.
- (2) The bidders' past performance in meeting the DBE goals.
- (3) The performance of other bidders in meeting the DBE goal. For example, when the apparent successful bidder fails to meet the DBE goal, but others meet it, you may reasonably raise the question of whether, with additional reasonable efforts the apparent successful bidder could have met the goal. If the apparent successful bidder fails to meet the DBE goal, but meets or exceeds the average DBE participation obtained by other bidders, the Department may view this, in conjunction with other factors, as evidence of the apparent successful bidder having made a good faith effort.

If the Department does not award the contract to the apparent lowest responsive bidder, the Department reserves the right to award the contract to the next lowest responsive bidder that can satisfy to the Department that the DBE goal can be met or that an adequate good faith effort has been made to meet the DBE goal.

### **Non-Good Faith Appeal**

The Engineer will notify the contractor verbally and in writing of non-good faith. A contractor may appeal a determination of non-good faith made by the Goal Compliance Committee. If a contractor wishes to appeal the determination made by the Committee, they shall provide written notification to the Engineer. The appeal shall be made within 2 business days of notification of the determination of non-good faith.

**Counting DBE Participation Toward Meeting DBE Goal****(A) Participation**

The total dollar value of the participation by a committed DBE will be counted toward the contract goal requirement. The total dollar value of participation by a committed DBE will be based upon the value of work actually performed by the DBE and the actual payments to DBE firms by the Contractor.

**(B) Joint Checks**

Prior notification of joint check use shall be required when counting DBE participation for services or purchases that involves the use of a joint check. Notification shall be through submission of Form JC-1 (*Joint Check Notification Form*) and the use of joint checks shall be in accordance with the Department's Joint Check Procedures.

**(C) Subcontracts (Non-Trucking)**

A DBE may enter into subcontracts. Work that a DBE subcontracts to another DBE firm may be counted toward the contract goal requirement. Work that a DBE subcontracts to a non-DBE firm does not count toward the contract goal requirement. If a DBE contractor or subcontractor subcontracts a significantly greater portion of the work of the contract than would be expected on the basis of standard industry practices, it shall be presumed that the DBE is not performing a commercially useful function. The DBE may present evidence to rebut this presumption to the Department. The Department's decision on the rebuttal of this presumption is subject to review by the Federal Highway Administration but is not administratively appealable to USDOT.

**(D) Joint Venture**

When a DBE performs as a participant in a joint venture, the Contractor may count toward its contract goal requirement a portion of the total value of participation with the DBE in the joint venture, that portion of the total dollar value being a distinct clearly defined portion of work that the DBE performs with its forces.

**(E) Suppliers**

A contractor may count toward its DBE requirement 60 percent of its expenditures for materials and supplies required to complete the contract and obtained from a DBE regular dealer and 100 percent of such expenditures from a DBE manufacturer.

**(F) Manufacturers and Regular Dealers**

A contractor may count toward its DBE requirement the following expenditures to DBE firms that are not manufacturers or regular dealers:

- (1) The fees or commissions charged by a DBE firm for providing a *bona fide* service, such as professional, technical, consultant, or managerial services, or for providing bonds or insurance specifically required for the performance of a DOT-assisted contract, provided the fees or commissions are determined to be reasonable and not excessive as compared with fees and commissions customarily allowed for similar services.

- (2) With respect to materials or supplies purchased from a DBE, which is neither a manufacturer nor a regular dealer, count the entire amount of fees or commissions charged for assistance in the procurement of the materials and supplies, or fees or transportation charges for the delivery of materials or supplies required on a job site (but not the cost of the materials and supplies themselves), provided the fees are determined to be reasonable and not excessive as compared with fees customarily allowed for similar services.

### **Commercially Useful Function**

#### **(A) DBE Utilization**

The Contractor may count toward its contract goal requirement only expenditures to DBEs that perform a commercially useful function in the work of a contract. A DBE performs a commercially useful function when it is responsible for execution of the work of the contract and is carrying out its responsibilities by actually performing, managing, and supervising the work involved. To perform a commercially useful function, the DBE shall also be responsible with respect to materials and supplies used on the contract, for negotiating price, determining quality and quantity, ordering the material and installing (where applicable) and paying for the material itself. To determine whether a DBE is performing a commercially useful function, the Department will evaluate the amount of work subcontracted, industry practices, whether the amount the firm is to be paid under the contract is commensurate with the work it is actually performing and the DBE credit claimed for its performance of the work, and any other relevant factors.

#### **(B) DBE Utilization in Trucking**

The following factors will be used to determine if a DBE trucking firm is performing a commercially useful function:

- (1) The DBE shall be responsible for the management and supervision of the entire trucking operation for which it is responsible on a particular contract, and there shall not be a contrived arrangement for the purpose of meeting DBE goals.
- (2) The DBE shall itself own and operate at least one fully licensed, insured, and operational truck used on the contract.
- (3) The DBE receives credit for the total value of the transportation services it provides on the contract using trucks it owns, insures, and operates using drivers it employs.
- (4) The DBE may subcontract the work to another DBE firm, including an owner-operator who is certified as a DBE. The DBE who subcontracts work to another DBE receives credit for the total value of the transportation services the subcontracted DBE provides on the contract.
- (5) The DBE may also subcontract the work to a non-DBE firm, including from an owner-operator. The DBE who subcontracts the work to a non-DBE is entitled to credit for the total value of transportation services provided by the non-DBE subcontractor not to exceed the value of transportation services provided by DBE-owned trucks on the contract. Additional participation by non-DBE subcontractors receives credit only for the fee or commission it receives as

a result of the subcontract arrangement. The value of services performed under subcontract agreements between the DBE and the Contractor will not count towards the DBE contract requirement.

- (6) A DBE may lease truck(s) from an established equipment leasing business open to the general public. The lease must indicate that the DBE has exclusive use of and control over the truck. This requirement does not preclude the leased truck from working for others during the term of the lease with the consent of the DBE, so long as the lease gives the DBE absolute priority for use of the leased truck. This type of lease may count toward the DBE's credit as long as the driver is under the DBE's payroll.
- (7) Subcontracted/leased trucks shall display clearly on the dashboard the name of the DBE that they are subcontracted/leased to and their own company name if it is not identified on the truck itself. Magnetic door signs are not permitted.

### **DBE Replacement**

When a Contractor has relied on a commitment to a DBE subcontractor (or an approved substitute DBE subcontractor) to meet all or part of a contract goal requirement, the contractor shall not terminate the DBE subcontractor for convenience. This includes, but is not limited to, instances in which the Contractor seeks to perform the work of the terminated subcontractor with another DBE subcontractor, a non-DBE subcontractor, or with the Contractor's own forces or those of an affiliate.

The Contractor must give notice in writing both by certified mail and email to the DBE subcontractor, with a copy to the Engineer of its intent to request to terminate and/or substitute, and the reason for the request. The Contractor must give the DBE subcontractor five (5) business days to respond to the Contractor's Notice of Intent to Request Termination and/or Substitution. If the DBE subcontractor objects to the intended termination/substitution, the DBE, within five (5) business days must advise the Contractor and the Department of the reasons why the action should not be approved. The five-day notice period shall begin on the next business day after written notice is provided to the DBE subcontractor.

A committed DBE subcontractor may only be terminated after receiving the Department's written approval based upon a finding of good cause for the proposed termination and/or substitution. For purposes of this section, good cause shall include the following circumstances:

- (a) The listed DBE subcontractor fails or refuses to execute a written contract;
- (b) The listed DBE subcontractor fails or refuses to perform the work of its subcontract in a way consistent with normal industry standards. Provided, however, that good cause does not exist if the failure or refusal of the DBE subcontractor to perform its work on the subcontract results from the bad faith or discriminatory action of the prime contractor;
- (c) The listed DBE subcontractor fails or refuses to meet the prime contractor's reasonable, nondiscriminatory bond requirements;
- (d) The listed DBE subcontractor becomes bankrupt, insolvent, or exhibits credit unworthiness;
- (e) The listed DBE subcontractor is ineligible to work on public works projects because of suspension and debarment proceedings pursuant to 2 CFR Parts 180, 215 and 1,200 or applicable state law;
- (f) The listed DBE subcontractor is not a responsible contractor;

- (g) The listed DBE voluntarily withdraws from the project and provides written notice of withdrawal;
- (h) The listed DBE is ineligible to receive DBE credit for the type of work required;
- (i) A DBE owner dies or becomes disabled with the result that the listed DBE contractor is unable to complete its work on the contract;
- (j) Other documented good cause that compels the termination of the DBE subcontractor. Provided, that good cause does not exist if the prime contractor seeks to terminate a DBE it relied upon to obtain the contract so that the prime contractor can self-perform the work for which the DBE contractor was engaged or so that the prime contractor can substitute another DBE or non-DBE contractor after contract award.

The Contractor shall comply with the following for replacement of a committed DBE:

(A) Performance Related Replacement

When a committed DBE is terminated for good cause as stated above, an additional DBE that was submitted at the time of bid may be used to fulfill the DBE commitment. A good faith effort will only be required for removing a committed DBE if there were no additional DBEs submitted at the time of bid to cover the same amount of work as the DBE that was terminated.

If a replacement DBE is not found that can perform at least the same amount of work as the terminated DBE, the Contractor shall submit a good faith effort documenting the steps taken. Such documentation shall include, but not be limited to, the following:

- (1) Copies of written notification to DBEs that their interest is solicited in contracting the work defaulted by the previous DBE or in subcontracting other items of work in the contract.
- (2) Efforts to negotiate with DBEs for specific subbids including, at a minimum:
  - (a) The names, addresses, and telephone numbers of DBEs who were contacted.
  - (b) A description of the information provided to DBEs regarding the plans and specifications for portions of the work to be performed.
- (3) A list of reasons why DBE quotes were not accepted.
- (4) Efforts made to assist the DBEs contacted, if needed, in obtaining bonding or insurance required by the Contractor.

(B) Decertification Replacement

- (1) When a committed DBE is decertified by the Department after the SAF (*Subcontract Approval Form*) has been received by the Department, the Department will not require the Contractor to solicit replacement DBE participation equal to the remaining work to be performed by the decertified firm. The participation equal to the remaining work performed by the decertified firm will count toward the contract goal requirement.
- (2) When a committed DBE is decertified prior to the Department receiving the SAF (*Subcontract Approval Form*) for the named DBE firm, the Contractor shall take all necessary and reasonable steps to replace the DBE subcontractor with another DBE subcontractor to perform at least the same amount of work to meet the DBE goal

requirement. If a DBE firm is not found to do the same amount of work, a good faith effort must be submitted to NCDOT (see A herein for required documentation).

- (3) Exception: If the DBE's ineligibility is caused solely by its having exceeded the size standard during the performance of the contract, the Department will not require the Contractor to solicit replacement DBE participation equal to the remaining work to be performed by the decertified firm. The participation equal to the remaining work performed by the decertified firm will count toward the contract goal requirement and overall goal.

All requests for replacement of a committed DBE firm shall be submitted to the Engineer for approval on Form RF-1 (*DBE Replacement Request*). If the Contractor fails to follow this procedure, the Contractor may be disqualified from further bidding for a period of up to 6 months

### **Changes in the Work**

When the Engineer makes changes that result in the reduction or elimination of work to be performed by a committed DBE, the Contractor will not be required to seek additional participation. When the Engineer makes changes that result in additional work to be performed by a DBE based upon the Contractor's commitment, the DBE shall participate in additional work to the same extent as the DBE participated in the original contract work.

When the Engineer makes changes that result in extra work, which has more than a minimal impact on the contract amount, the Contractor shall seek additional participation by DBEs unless otherwise approved by the Engineer.

When the Engineer makes changes that result in an alteration of plans or details of construction, and a portion or all of the work had been expected to be performed by a committed DBE, the Contractor shall seek participation by DBEs unless otherwise approved by the Engineer.

When the Contractor requests changes in the work that result in the reduction or elimination of work that the Contractor committed to be performed by a DBE, the Contractor shall seek additional participation by DBEs equal to the reduced DBE participation caused by the changes.

### **Reports and Documentation**

A SAF (*Subcontract Approval Form*) shall be submitted for all work which is to be performed by a DBE subcontractor. The Department reserves the right to require copies of actual subcontract agreements involving DBE subcontractors.

When using transportation services to meet the contract commitment, the Contractor shall submit a proposed trucking plan in addition to the SAF. The plan shall be submitted prior to beginning construction on the project. The plan shall include the names of all trucking firms proposed for use, their certification type(s), the number of trucks owned by the firm, as well as the individual truck identification numbers, and the line item(s) being performed.

Within 30 calendar days of entering into an agreement with a DBE for materials, supplies or services, not otherwise documented by the SAF as specified above, the Contractor shall furnish the Engineer a copy of the agreement. The documentation shall also indicate the percentage (60% or 100%) of expenditures claimed for DBE credit.

**Reporting Disadvantaged Business Enterprise Participation**

The Contractor shall provide the Engineer with an accounting of payments made to all DBE firms, including material suppliers and contractors at all levels (prime, subcontractor, or second tier subcontractor). This accounting shall be furnished to the Engineer for any given month by the end of the following month. Failure to submit this information accordingly may result in the following action:

- (A) Withholding of money due in the next partial pay estimate; or
- (B) Removal of an approved contractor from the prequalified bidders' list or the removal of other entities from the approved subcontractors list.

While each contractor (prime, subcontractor, 2nd tier subcontractor) is responsible for accurate accounting of payments to DBEs, it shall be the prime contractor's responsibility to report all monthly and final payment information in the correct reporting manner.

Failure on the part of the Contractor to submit the required information in the time frame specified may result in the disqualification of that contractor and any affiliate companies from further bidding until the required information is submitted.

Failure on the part of any subcontractor to submit the required information in the time frame specified may result in the disqualification of that contractor and any affiliate companies from being approved for work on future projects until the required information is submitted.

Contractors reporting transportation services provided by non-DBE lessees shall evaluate the value of services provided during the month of the reporting period only.

At any time, the Engineer can request written verification of subcontractor payments.

The Contractor shall report the accounting of payments through the Department's DBE Payment Tracking System.

**Failure to Meet Contract Requirements**

Failure to meet contract requirements in accordance with Subarticle 102-15(J) of the *2018 Standard Specifications* may be cause to disqualify the Contractor.

**CERTIFICATION FOR FEDERAL-AID CONTRACTS:**

(3-21-90)

SP1 G85

The prospective participant certifies, by signing and submitting this bid or proposal, to the best of his or her knowledge and belief, that:

- (A) No Federal appropriated funds have been paid or will be paid, by or on behalf of the undersigned, to any person for influencing or attempting to influence an officer or employee of any Federal agency, a Member of Congress, an officer or employee of Congress, or an employee of a Member of Congress in connection with the awarding of any Federal contract, the making of any Federal grant, the making of any Federal loan, the entering into of any cooperative agreement, and the extension, continuation, renewal, amendment, or modification of any Federal contract, grant, loan, or cooperative agreement.

- (B) If any funds other than Federal appropriated funds have been paid or will be paid to any person for influencing or attempting to influence an officer or employee of any Federal agency, a Member of Congress, an officer or employee of Congress, or an employee of a Member of Congress in connection with this Federal contract, grant, loan, or cooperative agreement, the undersigned shall complete and submit Standard Form-LLL, *Disclosure Form to Report Lobbying*, in accordance with its instructions.

This certification is a material representation of fact upon which reliance was placed when this transaction was made or entered into. Submission of this certification is a prerequisite for making or entering into this transaction imposed by *Section 1352, Title 31, U.S. Code*. Any person who fails to file the required certification shall be subject to a civil penalty of not less than \$10,000 and not more than \$100,000 for each such failure.

The prospective participant also agrees by submitting his or her bid or proposal that he or she shall require that the language of this certification be included in all lower tier subcontracts, which exceed \$100,000 and that all such subrecipients shall certify and disclose accordingly.

**CONTRACTOR'S LICENSE REQUIREMENTS:**

(7-1-95)

102-14

SP1 G88

If the successful bidder does not hold the proper license to perform any plumbing, heating, air conditioning, or electrical work in this contract, he will be required to sublet such work to a contractor properly licensed in accordance with *Article 2 of Chapter 87 of the General Statutes* (licensing of heating, plumbing, and air conditioning contractors) and *Article 4 of Chapter 87 of the General Statutes* (licensing of electrical contractors).

**RESTRICTIONS ON ITS EQUIPMENT AND SERVICES:**

(11-17-20)

SP01 G090

All telecommunications, video or other ITS equipment or services installed or utilized on this project must be in conformance with UNIFORM ADMINISTRATIVE REQUIREMENTS, COST PRINCIPLES, AND AUDIT REQUIREMENTS FOR FEDERAL AWARDS 2 CFR, § 200.216 **Prohibition on certain telecommunications and video surveillance services or equipment.**

**USE OF UNMANNED AIRCRAFT SYSTEM (UAS):**

(8-20-19)

SP1 G092

The Contractor shall adhere to all Federal, State and Local regulations and guidelines for the use of Unmanned Aircraft Systems (UAS). This includes but is not limited to US 14 CFR Part 107 *Small UAS Rule*, NC GS 15A-300.2 *Regulation of launch and recovery sites*, NC GS 63-95 *Training required for the operation of unmanned aircraft systems*, NC GS 63-96 *Permit required for commercial operation of unmanned aircraft system*, and NCDOT UAS Policy. The required operator certifications include possessing a current Federal Aviation Administration (FAA) Remote Pilot Certificate, a NC UAS Operator Permit as well as operating a UAS registered with the FAA.

Prior to beginning operations, the Contractor shall complete the NCDOT UAS – Flight Operation Approval Form and submit it to the Engineer for approval. All UAS operations shall be approved by the Engineer prior to beginning the operations.

All contractors or subcontractors operating UAS shall have UAS specific general liability insurance to cover all operations under this contract.



The use of UAS is at the Contractor's discretion. No measurement or payment will be made for the use of UAS. In the event that the Department directs the Contractor to utilize UAS, payment will be in accordance with Article 104-7 Extra Work.

**EQUIPMENT IDLING GUIDELINES:**

(1-19-21)

107

SP1 G096

Exercise reduced fuel consumption and reduced equipment emissions during the construction of all work associated with this contract. Employees engaged in the construction of this project should turn off vehicles when stopped for more than thirty (30) minutes and off-highway equipment should idle no longer than fifteen (15) consecutive minutes.

These guidelines for turning off vehicles and equipment when idling do not apply to:

1. Idling when queuing.
2. Idling to verify the vehicle is in safe operating condition.
3. Idling for testing, servicing, repairing or diagnostic purposes.
4. Idling necessary to accomplish work for which the vehicle was designed (such as operating a crane, mixing concrete, etc.).
5. Idling required to bring the machine system to operating temperature.
6. Emergency vehicles, utility company, construction, and maintenance vehicles where the engines must run to perform needed work.
7. Idling to ensure safe operation of the vehicle.
8. Idling when the propulsion engine is providing auxiliary power for other than heating or air conditioning. (such as hydraulic systems for pavers)
9. When specific traffic, safety, or emergency situations arise.
10. If the ambient temperature is less than 32 degrees Fahrenheit. Limited idling to provide for the safety of vehicle occupants (e.g. to run the heater).
11. If the ambient temperature is greater than 90 degrees Fahrenheit. Limited idling to provide for the safety of vehicle occupants of off-highway equipment (e.g. to run the air conditioning) no more than 30 minutes.
12. Diesel powered vehicles may idle for up to 30 minutes to minimize restart problems.

Any vehicle, truck, or equipment in which the primary source of fuel is natural gas or electricity is exempt from the idling limitations set forth in this special provision.

**U.S. DEPARTMENT OF TRANSPORTATION HOTLINE:**

(11-22-94)

108-5

SP1 G100

To report bid rigging activities call: **1-800-424-9071**

The U.S. Department of Transportation (DOT) operates the above toll-free hotline Monday through Friday, 8:00 a.m. to 5:00 p.m. eastern time. Anyone with knowledge of possible bid rigging, bidder collusion, or other fraudulent activities should use the hotline to report such activities.

The hotline is part of the DOT's continuing effort to identify and investigate highway construction contract fraud and abuse is operated under the direction of the DOT Inspector General. All information will be treated confidentially and caller anonymity will be respected.

**CARGO PREFERENCE ACT:**

(2-16-16)

Privately owned United States-flag commercial vessels transporting cargoes are subject to the Cargo Preference Act (CPA) of 1954 requirements and regulations found in 46 CFR 381.7. Contractors are directed to clause (b) of 46 CFR 381.7 as follows:

(b) Contractor and Subcontractor Clauses. "Use of United States-flag vessels: The contractor agrees-

" (1) To utilize privately owned United States-flag commercial vessels to ship at least 50 percent of the gross tonnage (computed separately for dry bulk carriers, dry cargo liners, and tankers) involved, whenever shipping any equipment, material, or commodities pursuant to this contract, to the extent such vessels are available at fair and reasonable rates for United States-flag commercial vessels.

(2) To furnish within 20 days following the date of loading for shipments originating within the United States or within 30 working days following the date of loading for shipments originating outside the United States a legible copy of a rated, 'on-board' commercial ocean bill-of-lading in English for each shipment of cargo described in paragraph (b) (1) of this section to both the Contracting Officer (through the prime contractor in the case of subcontractor bills-of-lading) and to the Division of National Cargo, Office of Market Development, Maritime Administration, Washington, DC 20590.

(3) To insert the substance of the provisions of this clause in all subcontracts issued pursuant to this contract."

**ELECTRONIC BIDDING:**

(2-19-19)

101, 102, 103

SP1 G140

Revise the *2018 Standard Specifications* as follows:

**Page 1-4, Article 101-3, DEFINITIONS, BID (OR PROPOSAL) *Electronic Bid*, line 1**, replace "Bid Express®" with "the approved electronic bidding provider".

**Page 1-15, Subarticle 102-8(B), *Electronic Bids*, lines 39-40**, replace "to Bid Express®" with "via the approved electronic bidding provider".

**Page 1-15, Subarticle 102-8(B)(1), *Electronic Bids*, line 41**, delete "from Bid Express®"

**Page 1-17, Subarticle 102-9(C)(2), *Electronic Bids*, line 21**, replace "Bid Express® miscellaneous folder within the .ebs" with "electronic submittal".

**Page 1-29, Subarticle 103-4(C)(2), *Electronic Bids*, line 32**, replace ".ebs miscellaneous data file of Expedite" with "electronic submittal file"

**AWARD LIMITS:**

(4-19-22)

103

SP1 G141

Revise the *2018 Standard Specifications* as follows:

**Page 1-29, Subarticle 103-4(C), Award Limits**, line 4-8, delete and replace the first sentence in the first paragraph with the following:

A bidder who desires to bid on more than one project on which bids are to be opened in the same letting and who desires to avoid receiving an award of more projects than he is equipped to handle, may bid on any number of projects but may limit the total amount of work awarded to him on selected projects by completing the form Award Limits on Multiple Projects for each project subject to the award limit.

**TWELVE MONTH GUARANTEE:**

(7-15-03)

108

SP1 G145

- (A) The Contractor shall guarantee materials and workmanship against latent and patent defects arising from faulty materials, faulty workmanship or negligence for a period of twelve months following the date of final acceptance of the work for maintenance and shall replace such defective materials and workmanship without cost to the Department. The Contractor will not be responsible for damage due to faulty design, normal wear and tear, for negligence on the part of the Department, and/or for use in excess of the design.
- (B) Where items of equipment or material carry a manufacturer's guarantee for any period in excess of twelve months, then the manufacturer's guarantee shall apply for that particular piece of equipment or material. The Department's first remedy shall be through the manufacturer although the Contractor is responsible for invoking the warranted repair work with the manufacturer. The Contractor's responsibility shall be limited to the term of the manufacturer's guarantee. NCDOT would be afforded the same warranty as provided by the Manufacturer.

This guarantee provision shall be invoked only for major components of work in which the Contractor would be wholly responsible for under the terms of the contract. Examples would include pavement structures, bridge components, and sign structures. This provision will not be used as a mechanism to force the Contractor to return to the project to make repairs or perform additional work that the Department would normally compensate the Contractor for. In addition, routine maintenance activities (i.e. mowing grass, debris removal, ruts in earth shoulders,) are not parts of this guarantee.

Appropriate provisions of the payment and/or performance bonds shall cover this guarantee for the project.

To ensure uniform application statewide the Division Engineer will forward details regarding the circumstances surrounding any proposed guarantee repairs to the Chief Engineer for review and approval prior to the work being performed.

**EROSION AND SEDIMENT CONTROL/STORMWATER CERTIFICATION:**

(1-16-07) (Rev 12-15-20)

105-16, 225-2, 16

SPI G180

**General**

Schedule and conduct construction activities in a manner that will minimize soil erosion and the resulting sedimentation and turbidity of surface waters. Comply with the requirements herein regardless of whether or not a National Pollution discharge Elimination System (NPDES) permit for the work is required.

Establish a chain of responsibility for operations and subcontractors' operations to ensure that the *Erosion and Sediment Control/Stormwater Pollution Prevention Plan* is implemented and maintained over the life of the contract.

- (A) *Certified Supervisor* - Provide a certified Erosion and Sediment Control/Stormwater Supervisor to manage the Contractor and subcontractor operations, insure compliance with Federal, State and Local ordinances and regulations, and manage the Quality Control Program.
- (B) *Certified Foreman* - Provide a certified, trained foreman for each construction operation that increases the potential for soil erosion or the possible sedimentation and turbidity of surface waters.
- (C) *Certified Installer* - Provide a certified installer to install or direct the installation for erosion or sediment/stormwater control practices.
- (D) *Certified Designer* - Provide a certified designer for the design of the erosion and sediment control/stormwater component of reclamation plans and, if applicable, for the design of the project erosion and sediment control/stormwater plan.

**Roles and Responsibilities**

- (A) *Certified Erosion and Sediment Control/Stormwater Supervisor* - The Certified Supervisor shall be Level II and responsible for ensuring the erosion and sediment control/stormwater plan is adequately implemented and maintained on the project and for conducting the quality control program. The Certified Supervisor shall be on the project within 24 hours notice from initial exposure of an erodible surface to the project's final acceptance. Perform the following duties:
  - (1) *Manage Operations* - Coordinate and schedule the work of subcontractors so that erosion and sediment control/stormwater measures are fully executed for each operation and in a timely manner over the duration of the contract.
    - (a) Oversee the work of subcontractors so that appropriate erosion and sediment control/stormwater preventive measures are conformed to at each stage of the work.
    - (b) Prepare the required National Pollutant Discharge Elimination System (NPDES) Inspection Record and submit to the Engineer.
    - (c) Attend all weekly or monthly construction meetings to discuss the findings of the NPDES inspection and other related issues.
    - (d) Implement the erosion and sediment control/stormwater site plans requested.
    - (e) Provide any needed erosion and sediment control/stormwater practices for the Contractor's temporary work not shown on the plans, such as, but not limited to work platforms, temporary construction, pumping operations, plant and storage yards, and cofferdams.

- (f) Acquire applicable permits and comply with requirements for borrow pits, dewatering, and any temporary work conducted by the Contractor in jurisdictional areas.
  - (g) Conduct all erosion and sediment control/stormwater work in a timely and workmanlike manner.
  - (h) Fully perform and install erosion and sediment control/stormwater work prior to any suspension of the work.
  - (i) Coordinate with Department, Federal, State and Local Regulatory agencies on resolution of erosion and sediment control/stormwater issues due to the Contractor's operations.
  - (j) Ensure that proper cleanup occurs from vehicle tracking on paved surfaces or any location where sediment leaves the Right-of-Way.
  - (k) Have available a set of erosion and sediment control/stormwater plans that are initialed and include the installation date of Best Management Practices. These practices shall include temporary and permanent groundcover and be properly updated to reflect necessary plan and field changes for use and review by Department personnel as well as regulatory agencies.
- (2) Requirements set forth under the NPDES Permit - The Department's NPDES Stormwater permit (NCS000250) outlines certain objectives and management measures pertaining to construction activities. The permit references *NCG010000, General Permit to Discharge Stormwater* under the NPDES, and states that the Department shall incorporate the applicable requirements into its delegated Erosion and Sediment Control Program for construction activities disturbing one or more acres of land. The Department further incorporates these requirements on all contracted bridge and culvert work at jurisdictional waters, regardless of size. Some of the requirements are, but are not limited to:
- (a) Control project site waste to prevent contamination of surface or ground waters of the state, i.e. from equipment operation/maintenance, construction materials, concrete washout, chemicals, litter, fuels, lubricants, coolants, hydraulic fluids, any other petroleum products, and sanitary waste.
  - (b) Inspect erosion and sediment control/stormwater devices and stormwater discharge outfalls at least once every 7 calendar days and within 24 hours after a rainfall event equal to or greater than 1.0 inch that occurs within a 24 hour period. Additional monitoring may be required at the discretion of Division of Water Resources personnel if the receiving stream is 303(d) listed for turbidity and the project has had documented problems managing turbidity.
  - (c) Maintain an onsite rain gauge or use the Department's Multi-Sensor Precipitation Estimate website to maintain a daily record of rainfall amounts and dates.
  - (d) Maintain erosion and sediment control/stormwater inspection records for review by Department and Regulatory personnel upon request.
  - (e) Implement approved reclamation plans on all borrow pits, waste sites and staging areas.
  - (f) Maintain a log of turbidity test results as outlined in the Department's Procedure for Monitoring Borrow Pit Discharge.
  - (g) Provide secondary containment for bulk storage of liquid materials.
  - (h) Provide training for employees concerning general erosion and sediment control/stormwater awareness, the Department's NPDES Stormwater Permit NCS000250 requirements, and the applicable requirements of the *General Permit, NCG010000*.

- (i) Report violations of the NPDES permit to the Engineer immediately who will notify the Division of Water Quality Regional Office within 24 hours of becoming aware of the violation.
- (3) Quality Control Program - Maintain a quality control program to control erosion, prevent sedimentation and follow provisions/conditions of permits. The quality control program shall:
- (a) Follow permit requirements related to the Contractor and subcontractors' construction activities.
  - (b) Ensure that all operators and subcontractors on site have the proper erosion and sediment control/stormwater certification.
  - (c) Notify the Engineer when the required certified erosion and sediment control/stormwater personnel are not available on the job site when needed.
  - (d) Conduct the inspections required by the NPDES permit.
  - (e) Take corrective actions in the proper timeframe as required by the NPDES permit for problem areas identified during the NPDES inspections.
  - (f) Incorporate erosion control into the work in a timely manner and stabilize disturbed areas with mulch/seed or vegetative cover on a section-by-section basis.
  - (g) Use flocculants approved by state regulatory authorities where appropriate and where required for turbidity and sedimentation reduction.
  - (h) Ensure proper installation and maintenance of temporary erosion and sediment control devices.
  - (i) Remove temporary erosion or sediment control devices when they are no longer necessary as agreed upon by the Engineer.
  - (j) The Contractor's quality control and inspection procedures shall be subject to review by the Engineer. Maintain NPDES inspection records and make records available at all times for verification by the Engineer.
- (B) *Certified Foreman* - At least one Certified Foreman shall be onsite for each type of work listed herein during the respective construction activities to control erosion, prevent sedimentation and follow permit provisions:
- (1) Foreman in charge of grading activities
  - (2) Foreman in charge of bridge or culvert construction over jurisdictional areas
  - (3) Foreman in charge of utility activities
- The Contractor may request to use the same person as the Level II Supervisor and Level II Foreman. This person shall be onsite whenever construction activities as described above are taking place. This request shall be approved by the Engineer prior to work beginning.
- The Contractor may request to name a single Level II Foreman to oversee multiple construction activities on small bridge or culvert replacement projects. This request shall be approved by the Engineer prior to work beginning.
- (C) *Certified Installers* - Provide at least one onsite, Level I Certified Installer for each of the following erosion and sediment control/stormwater crew:
- (1) Seeding and Mulching
  - (2) Temporary Seeding
  - (3) Temporary Mulching

- (4) Sodding
- (5) Silt fence or other perimeter erosion/sediment control device installations
- (6) Erosion control blanket installation
- (7) Hydraulic tackifier installation
- (8) Turbidity curtain installation
- (9) Rock ditch check/sediment dam installation
- (10) Ditch liner/matting installation
- (11) Inlet protection
- (12) Riprap placement
- (13) Stormwater BMP installations (such as but not limited to level spreaders, retention/detention devices)
- (14) Pipe installations within jurisdictional areas

If a Level I *Certified Installer* is not onsite, the Contractor may substitute a Level II Foreman for a Level I Installer, provided the Level II Foreman is not tasked to another crew requiring Level II Foreman oversight.

- (D) *Certified Designer* - Include the certification number of the Level III Certified Designer on the erosion and sediment control/stormwater component of all reclamation plans and if applicable, the certification number of the Level III Certified Designer on the design of the project erosion and sediment control/stormwater plan.

### **Preconstruction Meeting**

Furnish the names of the *Certified Erosion and Sediment Control/Stormwater Supervisor*, *Certified Foremen*, *Certified Installers* and *Certified Designer* and notify the Engineer of changes in certified personnel over the life of the contract within 2 days of change.

### **Ethical Responsibility**

Any company performing work for the North Carolina Department of Transportation has the ethical responsibility to fully disclose any reprimand or dismissal of an employee resulting from improper testing or falsification of records.

### **Revocation or Suspension of Certification**

Upon recommendation of the Chief Engineer to the certification entity, certification for *Supervisor*, *Certified Foremen*, *Certified Installers* and *Certified Designer* may be revoked or suspended with the issuance of an *Immediate Corrective Action (ICA)*, *Notice of Violation (NOV)*, or *Cease and Desist Order* for erosion and sediment control/stormwater related issues.

The Chief Engineer may recommend suspension or permanent revocation of certification due to the following:

- (A) Failure to adequately perform the duties as defined within this certification provision.
- (B) Issuance of an ICA, NOV, or Cease and Desist Order.
- (C) Failure to fully perform environmental commitments as detailed within the permit conditions and specifications.
- (D) Demonstration of erroneous documentation or reporting techniques.
- (E) Cheating or copying another candidate's work on an examination.
- (F) Intentional falsification of records.

- (G) Directing a subordinate under direct or indirect supervision to perform any of the above actions.
- (H) Dismissal from a company for any of the above reasons.
- (I) Suspension or revocation of one's certification by another entity.

Suspension or revocation of a certification will be sent by certified mail to the certificant and the Corporate Head of the company that employs the certificant.

A certificant has the right to appeal any adverse action which results in suspension or permanent revocation of certification by responding, in writing, to the Chief Engineer within 10 calendar days after receiving notice of the proposed adverse action.

Chief Engineer  
1536 Mail Service Center  
Raleigh, NC 27699-1536

Failure to appeal within 10 calendar days will result in the proposed adverse action becoming effective on the date specified on the certified notice. Failure to appeal within the time specified will result in a waiver of all future appeal rights regarding the adverse action taken. The certificant will not be allowed to perform duties associated with the certification during the appeal process.

The Chief Engineer will hear the appeal and make a decision within 7 days of hearing the appeal. Decision of the Chief Engineer will be final and will be made in writing to the certificant.

If a certification is temporarily suspended, the certificant shall pass any applicable written examination and any proficiency examination, at the conclusion of the specified suspension period, prior to having the certification reinstated.

### **Measurement and Payment**

*Certified Erosion and Sediment Control/Stormwater Supervisor, Certified Foremen, Certified Installers and Certified Designer* will be incidental to the project for which no direct compensation will be made.

### **PROCEDURE FOR MONITORING BORROW PIT DISCHARGE:**

(2-20-07) (Rev. 4-5-19)

105-16, 230, 801

SP1 G181

Water discharge from borrow pit sites shall not cause surface waters to exceed 50 NTUs (nephelometric turbidity unit) in streams not designated as trout waters and 10 NTUs in streams, lakes or reservoirs designated as trout waters. For lakes and reservoirs not designated as trout waters, the turbidity shall not exceed 25 NTUs. If the turbidity exceeds these levels due to natural background conditions, the existing turbidity level shall not be increased.

If during any operating day, the downstream water quality exceeds the standard, the Contractor shall do all of the following:

- (A) Either cease discharge or modify the discharge volume or turbidity levels to bring the downstream turbidity levels into compliance, or
- (B) Evaluate the upstream conditions to determine if the exceedance of the standard is due to natural background conditions. If the background turbidity measurements exceed the standard, operation of the pit and discharge can continue as long as the stream turbidity levels are not increased due to the discharge.



- (C) Measure and record the turbidity test results (time, date and sampler) at all defined sampling locations 30 minutes after startup and at a minimum, one additional sampling of all sampling locations during that 24-hour period in which the borrow pit is discharging.
- (D) Notify DWQ within 24 hours of any stream turbidity standard exceedances that are not brought into compliance.

During the Environmental Assessment required by Article 230-4 of the *2018 Standard Specifications*, the Contractor shall define the point at which the discharge enters into the State's surface waters and the appropriate sampling locations. Sampling locations shall include points upstream and downstream from the point at which the discharge enters these waters. Upstream sampling location shall be located so that it is not influenced by backwater conditions and represents natural background conditions. Downstream sampling location shall be located at the point where complete mixing of the discharge and receiving water has occurred.

The discharge shall be closely monitored when water from the dewatering activities is introduced into jurisdictional wetlands. Any time visible sedimentation (deposition of sediment) on the wetland surface is observed, the dewatering activity will be suspended until turbidity levels in the stilling basin can be reduced to a level where sediment deposition does not occur. Staining of wetland surfaces from suspended clay particles, occurring after evaporation or infiltration, does not constitute sedimentation. No activities shall occur in wetlands that adversely affect the functioning of a wetland. Visible sedimentation will be considered an indication of possible adverse impacts on wetland use.

The Engineer will perform independent turbidity tests on a random basis. These results will be maintained in a log within the project records. Records will include, at a minimum, turbidity test results, time, date and name of sampler. Should the Department's test results exceed those of the Contractor's test results, an immediate test shall be performed jointly with the results superseding the previous test results of both the Department and the Contractor.

The Contractor shall use the *NCDOT Turbidity Reduction Options for Borrow Pits Matrix*, available at <https://connect.ncdot.gov/resources/roadside/FieldOperationsDocuments/TurbidityReductionOptionSheet.pdf> to plan, design, construct, and maintain BMPs to address water quality standards. Tier I Methods include stilling basins which are standard compensatory BMPs. Other Tier I methods are noncompensatory and shall be used when needed to meet the stream turbidity standards. Tier II Methods are also noncompensatory and are options that may be needed for protection of rare or unique resources or where special environmental conditions exist at the site which have led to additional requirements being placed in the DWQ's 401 Certifications and approval letters, Isolated Wetland Permits, Riparian Buffer Authorization or a DOT Reclamation Plan's Environmental Assessment for the specific site. Should the Contractor exhaust all Tier I Methods on a site exclusive of rare or unique resources or special environmental conditions, Tier II Methods may be required by regulators on a case by case basis per supplemental agreement.

The Contractor may use cation exchange capacity (CEC) values from proposed site borings to plan and develop the bid for the project. CEC values exceeding 15 milliequivalents per 100 grams of soil may indicate a high potential for turbidity and should be avoided when dewatering into surface water is proposed.

No additional compensation for monitoring borrow pit discharge will be paid.

**PROJECT SPECIAL PROVISIONS****ROADWAY****SIGNAL CONTINGENCY:**

Due long lead times on the delivery of the metal strain poles, the following contingency shall be followed: A temporary signal system, using wooden poles, shall be installed and remain in place until such time as the contractor can take delivery of metal strain poles and install the fully-operational, permanent signal system.

**POLYPROPYLENE CULVERT PIPE:**

(8-20-19)

305,310

SP3 R35

Revise the *2018 Standard Specifications* as follows:

**Page 3-5, Article 305-1 DESCRIPTION**, lines 12-14, replace with the following:

Where shown in the plans, the Contractor may use reinforced concrete pipe, aluminum alloy pipe, aluminized corrugated steel pipe, HDPE pipe, Polypropylene Pipe, or PVC pipe in accordance with the following requirements.

**Page 3-5, Article 305-2 MATERIALS**, add the following after line 16:

<b>Item</b>	<b>Section</b>
Polypropylene Pipe	1032-9

**Page 3-6, Article 310-2 MATERIALS**, add the following after line 9:

<b>Item</b>	<b>Section</b>
Polypropylene Pipe	1032-9

**Page 3-6, Article 310-4 SIDE DRAIN PIPE**, lines 24-25, replace the first sentence of the second paragraph with the following:

Where shown in the plans, side drain pipe may be Class II reinforced concrete pipe, aluminized corrugated steel pipe, corrugated aluminum alloy pipe, polypropylene pipe, HDPE pipe or PVC pipe.

**Page 3-7, Article 310-5 PIPE END SECTIONS**, lines 2-4, replace the second sentence with the following:

Both corrugated steel and concrete pipe end sections will work on concrete pipe, corrugated steel pipe, polypropylene pipe, and HDPE smooth lined corrugated plastic pipe.

**Page 3-7, Article 310-6 MEASUREMENT AND PAYMENT**, add the following after line 14:

<b>Pay Item</b>	<b>Pay Unit</b>
__" Polypropylene Pipe	Linear Foot

**Page 10-60, add Article 1032-9:**

**(A) General**

Use polypropylene pipe from sources participating in the Department's Polypropylene Pipe QA/QC Program. A list of participating sources is available from the Materials and Tests Unit. The Department will remove a manufacturer of polypropylene pipe from this program if the monitoring efforts indicated that non-specification material is being provided or test procedures are not being followed.

Use polypropylene culvert pipe that meets AASHTO M 330 for Type S or Type D, or ASTM F2881 or ASTM F2764 Double or Triple wall; and has been evaluated by NTPEP.

**(B) End Treatments, Pipe Tees and Elbows**

End treatments, pipe tees and elbows shall meet AASHTO M 330, Section 7.7, or ASTM F2764, Section 6.6.

**(C) Marking**

Clearly mark each section of pipe, end section, tee and elbow and other accessories according to the Department's Polypropylene Pipe QC/QA Program:

- (1) AASHTO or ASTM Designation
- (2) The date of manufacture
- (3) Name or trademark of the manufacturer

When polypropylene pipe, end sections, tees and elbows have been inspected and accepted a sticker will be applied to the inside of the pipe. Do not use pipe sections, flared end sections, tees or elbows which do not have this seal of approval.

**SHOULDER WEDGE:**

(9-20-11) (Rev. 8-21-12)

610

SP6 R03R

Revise the *2018 Standard Specifications* as follows:

**Page 6-21, Article 610-8, SPREADING AND FINISHING**, add the following after line 39:

Attach a device, mounted on screed of paving equipment, capable of constructing a shoulder wedge with an angle of 30 degrees plus or minus 4 degrees along the outside edge of the roadway, measured from the horizontal plane in place after final compaction on the final surface course. Use an approved mechanical device which will form the asphalt mixture to produce a wedge with uniform texture, shape and density while automatically adjusting to varying heights.

Payment for use of this device will be incidental to the other pay items in the contract.

**PRICE ADJUSTMENT - ASPHALT BINDER FOR PLANT MIX:**

(11-21-00)

620

SP6 R25

Price adjustments for asphalt binder for plant mix will be made in accordance with Section 620 of the *2018 Standard Specifications*.

The base price index for asphalt binder for plant mix is \$ **509.55** per ton.

This base price index represents an average of F.O.B. selling prices of asphalt binder at supplier's terminals on **November 1, 2021**.

**FINAL SURFACE TESTING NOT REQUIRED:**

(5-18-04) (Rev. 2-16-16)

610

SP6 R45

Final surface testing is not required on this project in accordance with Section 610-13, *Final Surface Testing and Acceptance*.

**MILLING ASPHALT PAVEMENT:**

(1-15-19)

607

SP6 R59

Revise the *2018 Standard Specifications* as follows:

**Page 6-5, Article 607-2, EQUIPMENT, lines 14-16**, delete the seventh sentence of this Article and replace with the following:

Use either a non-contacting laser or sonar type ski system with a minimum of three referencing stations mounted on the milling machine at a length of at least 24 feet.

**ASPHALT CONCRETE PLANT MIX PAVEMENTS:**

(2-20-18) (Rev.1-15-19)

610, 1012

SP6 R65

Revise the *2018 Standard Specifications* as follows:

**Page 6-14, Table 609-3, LIMITS OF PRECISION FOR TEST RESULTS**, replace with the following:

<b>Mix Property</b>	<b>Limits of Precision</b>
25.0 mm sieve (Base Mix)	± 10.0%
19.0 mm sieve (Base Mix)	± 10.0%
12.5 mm sieve (Intermediate & Type P-57)	± 6.0%
9.5 mm sieve (Surface Mix)	± 5.0%
4.75 mm sieve (Surface Mix)	± 5.0%
2.36 mm sieve (All Mixes, except S4.75A)	± 5.0%
1.18 mm sieve (S4.75A)	± 5.0%
0.075 mm sieve (All Mixes)	± 2.0%
Asphalt Binder Content	± 0.5%
Maximum Specific Gravity ( $G_{mm}$ )	± 0.020
Bulk Specific Gravity ( $G_{mb}$ )	± 0.030
TSR	± 15.0%
QA retest of prepared QC Gyratory Compacted Volumetric Specimens	± 0.015

Retest of QC Core Sample	± 1.2% (% Compaction)
Comparison QA Core Sample	± 2.0% (% Compaction)
QA Verification Core Sample	± 2.0% (% Compaction)
Density Gauge Comparison of QC Test	± 2.0% (% Compaction)
QA Density Gauge Verification Test	± 2.0% (% Compaction)

Page 6-17, Table 610-1, MIXING TEMPERATURE AT THE ASPHALT PLANT, replace with the following:

TABLE 610-1 MIXING TEMPERATURE AT THE ASPHALT PLANT	
Binder Grade	JMF Temperature
PG 58-28; PG 64-22	250 - 290°F
PG 76-22	300 - 325°F

Page 6-17, Subarticle 610-3(C), Job Mix Formula (JMF), lines 38-39, delete the fourth paragraph.

Page 6-18, Subarticle 610-3(C), Job Mix Formula (JMF), line 12, replace “SF9.5A” with “S9.5B”.

Page 6-18, Table 610-3, MIX DESIGN CRITERIA, replace with the following:

TABLE 610-3 MIX DESIGN CRITERIA									
Mix Type	Design ESALs millions <sup>A</sup>	Binder PG Grade	Compaction Levels		Max. Rut Depth (mm)	Volumetric Properties <sup>B</sup>			
			G <sub>mm</sub> @			VMA % Min.	VTM %	VFA Min.-Max.	%G <sub>mm</sub> @ N <sub>ini</sub>
			N <sub>ini</sub>	N <sub>des</sub>					
S4.75A	< 1	64 - 22	6	50	11.5	16.0	4.0 - 6.0	65 - 80	≤ 91.5
S9.5B	0 - 3	64 - 22	6	50	9.5	16.0	3.0 - 5.0	70 - 80	≤ 91.5
S9.5C	3 - 30	64 - 22	7	65	6.5	15.5	3.0 - 5.0	65 - 78	≤ 90.5
S9.5D	> 30	76 - 22	8	100	4.5	15.5	3.0 - 5.0	65 - 78	≤ 90.0
I19.0C	ALL	64 - 22	7	65	-	13.5	3.0 - 5.0	65 - 78	≤ 90.5
B25.0C	ALL	64 - 22	7	65	-	12.5	3.0 - 5.0	65 - 78	≤ 90.5
Design Parameter					Design Criteria				
All Mix Types	Dust to Binder Ratio (P <sub>0.075</sub> / P <sub>be</sub> )				0.6 - 1.4 <sup>C</sup>				
	Tensile Strength Ratio (TSR) <sup>D</sup>				85% Min. <sup>E</sup>				

- A. Based on 20 year design traffic.
- B. Volumetric Properties based on specimens compacted to N<sub>des</sub> as modified by the Department.
- C. Dust to Binder Ratio (P<sub>0.075</sub> / P<sub>be</sub>) for Type S4.75A is 1.0 - 2.0.
- D. NCDOT-T-283 (No Freeze-Thaw cycle required).
- E. TSR for Type S4.75A & B25.0C mixes is 80% minimum.

Page 6-19, Table 610-5, BINDER GRADE REQUIREMENTS (BASED ON RBR%), replace with the following:

TABLE 610-5 BINDER GRADE REQUIREMENTS (BASED ON RBR%)			
Mix Type	%RBR ≤ 20%	21% ≤ %RBR ≤ 30%	%RBR ≥ 30%
S4.75A, S9.5B, S9.5C, I19.0C, B25.0C	PG 64-22	PG 64-22 <sup>A</sup>	PG-58-28
S9.5D, OGFC	PG 76-22 <sup>B</sup>	n/a	n/a

- A. If the mix contains any amount of RAS, the virgin binder shall be PG 58-28.
- B. Maximum Recycled Binder Replacement (%RBR) is 18% for mixes using PG 76-22 binder.

**Page 6-20, Table 610-6, PLACEMENT TEMPERATURES FOR ASPHALT**, replace with the following:

<b>Asphalt Concrete Mix Type</b>	<b>Minimum Surface and Air Temperature</b>
B25.0C	35°F
I19.0C	35°F
S4.75A, S9.5B, S9.5C	40°F <sup>A</sup>
S9.5D	50°F

- A. For the final layer of surface mixes containing recycled asphalt shingles (RAS), the minimum surface and air temperature shall be 50°F.

**Page 6-21, Article 610-8, SPREADING AND FINISHING, lines 34-35**, delete the second sentence and replace with the following:

Use an MTV for all surface mix regardless of binder grade on Interstate, US Routes, and NC Routes (primary routes) that have 4 or more lanes and median divided.

**Page 6-21, Article 610-8, SPREADING AND FINISHING, lines 36-38**, delete the fourth sentence and replace with the following:

Use MTV for all ramps, loops, Y-line that have 4 or more lanes and are median divided, full width acceleration lanes, full width deceleration lanes, and full width turn lanes that are greater than 1000 feet in length.

**Page 6-23, Table 610-7, DENSITY REQUIREMENTS**, replace with the following:

<b>Mix Type</b>	<b>Minimum % G<sub>mm</sub> (Maximum Specific Gravity)</b>
S4.75A	85.0 <sup>A</sup>
S9.5B	90.0
S9.5C, S9.5D, I19.0C, B25.0C	92.0

- A. Compaction to the above specified density will be required when the S4.75A mix is applied at a rate of 100 lbs/sy or higher.

**Page 6-24, Article 610-13, FINAL SURFACE TESTING, lines 35-36**, delete the second sentence and replace with the following:

Final surface testing is not required on ramps, loops and turn lanes.

**Page 6-26, Subarticle 610-13(A)(1), Acceptance for New Construction, lines 29-30**, delete the second sentence and replace with the following:

Areas excluded from testing by the profiler may be tested using a 10-foot straightedge in accordance with Article 610-12.

**Page 6-27, Subarticle 610-13(B), Option 2- North Carolina Hearne Straightedge, lines 41-46,** delete the eighth and ninth sentence of this paragraph and replace with the following:

Take profiles over the entire length of the final surface travel lane pavement exclusive of structures, approach slabs, paved shoulders, tapers, or other irregular shaped areas of pavement, unless otherwise approved by the Engineer. Test in accordance with this provision all mainline travel lanes, full width acceleration or deceleration lanes and collector lanes.

**Page 6-28, Subarticle 610-13(B), Option 2- North Carolina Hearne Straightedge, lines 1-2,** delete these two lines.

**Page 6-32, Article 610-16 MEASUREMENT AND PAYMENT,** replace with the following:

<b>Pay Item</b>	<b>Pay Unit</b>
Asphalt Concrete Base Course, Type B25.0C	Ton
Asphalt Concrete Intermediate Course, Type I19.0C	Ton
Asphalt Concrete Surface Course, Type S4.75A	Ton
Asphalt Concrete Surface Course, Type S9.5B	Ton
Asphalt Concrete Surface Course, Type S9.5C	Ton
Asphalt Concrete Surface Course, Type S9.5D	Ton

**Page 10-30, Table 1012-1, AGGREGATE CONSENSUS PROPERTIES,** replace with the following:

**TABLE 1012-1  
AGGREGATE CONSENSUS PROPERTIES<sup>A</sup>**

<b>Mix Type</b>	<b>Coarse Aggregate Angularity<sup>B</sup></b>	<b>Fine Aggregate Angularity % Minimum</b>	<b>Sand Equivalent % Minimum</b>	<b>Flat and Elongated 5 : 1 Ratio % Maximum</b>
<i>Test Method</i>	<i>ASTM D5821</i>	<i>AASHTO T 304</i>	<i>AASHTO T 176</i>	<i>ASTM D4791</i>
S4.75A; S9.5B	75 / -	40	40	-
S9.5C; I19.0C; B25.0C	95 / 90	45	45	10
S9.5D	100 / 100	45	50	10
OGFC	100 / 100	45	45	10
UBWC	100 / 85	45	45	10

**A.** Requirements apply to the design aggregate blend.

**B.** 95 / 90 denotes that 95% of the coarse aggregate has one fractured face and 90% has 2 or more fractured faces.

**AUTOMATED MACHINE GUIDANCE**

(1-2-11)

801

SP8 R01

**General**

This Special Provision contains requirements to be followed if the Contractor elects to use Global Positioning System (GPS) machine control grading and shall be used in conjunction with Section 801 of

the *Standard Specifications*. The use of this technology is referenced as Automated Machine Guidance (AMG).

All equipment using AMG shall be able to generate end results that meet the *Standard Specifications*. Perform test sections for each type of work to be completed with AMG to demonstrate that the system has the capability to achieve acceptable results. If acceptable results cannot be achieved, conform to the requirements for conventional stakeout.

The Contractor shall be responsible for all errors resulting from the use of AMG and shall correct deficiencies to the satisfaction of the Engineer at no cost to the Department.

### **Submittals**

If the Contractor elects to use AMG, a Digital Terrain Model (DTM) of the design surface and all intermediate surfaces shall be developed and submitted to the Engineer for review.

At least 90 days prior to beginning grading operations, the Contractor shall submit to the Engineer an AMG work plan to include, but not limited to, proposed equipment, control software manufacturer and version, types of work to be completed using AMG, project site calibration report, repetitive calibration methods for construction equipment and rover units to be used for the duration of the project, and local GPS base station to be used for broadcasting differential correction data to rover units (this may include the NC Network RTK). All surveys must be tied to existing project control as established by NCDOT.

### **Inspection**

The Engineer will perform quality assurance checks of all work associated with AMG. If it is determined that work is not being performed in a manner that will assure accurate results, the Engineer may require corrective action at no cost to the Department.

The Contractor shall provide the Engineer with one GPS rover unit for use during the duration of the contract. The rover will be loaded with the same model that is used with the AMG and have the same capability as rover units used by the Contractor. The rover will be kept in the possession of the Engineer and will be returned to the Contractor upon completion of the contract. Any maintenance or repairs required for the rover will be the responsibility of the Contractor. Formal training of at least 8 hours shall be provided to the Engineer by the Contractor on the use of the proposed AMG system.

### **Subgrade and Base Controls**

If the Contractor elects to use AMG for fine grading and placement of base or other roadway materials, the GPS shall be supplemented with a laser or robotic total station. Include details of the proposed system in the AMG work plan. In addition, the following requirements apply for the use of AMG for subgrade and base construction.

Provide control points at intervals along the project not to exceed 1,000 feet. The horizontal position of these points shall be determined by static GPS sessions or by traverse connection from the original base line control points. The elevation of these control points shall be established using differential leveling from project benchmarks, forming closed loops where practical. A copy of all new control point information shall be provided to the Engineer prior to construction activities.



Provide control points and conventional survey grade stakes at 500 foot intervals and at critical points such as, but not limited to, PCs, PTs, superelevation transition points, and other critical points as requested by the Engineer.

Provide hubs at the top of the finished subgrade at all hinge points on the cross section at 500 foot intervals. These hubs shall be established using conventional survey methods for use by the Engineer to check the accuracy of construction.

### Measurement and Payment

No direct payment will be made for work required to utilize this provision. All work will be considered incidental to various grading operations.

#### **SUPPLEMENTAL SURVEYING:**

(4-20-21)

801

SP8 R03

Revise the *2018 Standard Specifications* as follows:

**Page 8-7, Article 801-3 MEASUREMENT AND PAYMENT**, lines 10-11, replace with the following:

*Supplemental Surveying Office Calculations* will be paid at the stated price of \$85.00 per hour. *Supplemental Field Surveying* will be paid at the stated price of \$145.00 per hour. The

#### **GUARDRAIL END UNITS, TYPE - TL-3:**

(4-20-04) (Rev. 7-1-17)

862

SP8 R65

### Description

Furnish and install guardrail end units in accordance with the details in the plans, the applicable requirements of Section 862 of the *2018 Standard Specifications*, and at locations shown in the plans.

### Materials

Furnish guardrail end units listed on the NCDOT Approved Products List at <https://apps.dot.state.nc.us/vendor/approvedproducts/> or approved equal.

Prior to installation the Contractor shall submit to the Engineer:

- (A) FHWA acceptance letter for each guardrail end unit certifying it meets the requirements of the AASHTO Manual for Assessing Safety Hardware, Test Level 3, in accordance with Article 106-2 of the *2018 Standard Specifications*.
- (B) Certified working drawings and assembling instructions from the manufacturer for each guardrail end unit in accordance with Article 105-2 of the *2018 Standard Specifications*.

No modifications shall be made to the guardrail end unit without the express written permission from the manufacturer. Perform installation in accordance with the details in the plans, and details and assembling instructions furnished by the manufacturer.

**Construction Methods**

Guardrail end delineation is required on all approach and trailing end sections for both temporary and permanent installations. Guardrail end delineation consists of yellow reflective sheeting applied to the entire end section of the guardrail in accordance with Article 1088-3 of the *2018 Standard Specifications* and is incidental to the cost of the guardrail end unit.

**Measurement and Payment**

Measurement and payment will be made in accordance with Article 862-6 of the *2018 Standard Specifications*.

Payment will be made under:

<b>Pay Item</b>	<b>Pay Unit</b>
Guardrail End Units, Type TL-3	Each

**GUARDRAIL ANCHOR UNITS AND TEMPORARY GUARDRAIL ANCHOR UNITS:**

(1-16-2018)

862

SP8 R70

Guardrail anchor units will be in accordance with the details in the plans and the applicable requirements of Section 862 of the *2018 Standard Specifications*.

Revise the *2018 Standard Specifications* as follows:

**Page 8-42, Article 862-6 MEASUREMENT AND PAYMENT**, add the following:

*Guardrail Anchor Units, Type \_\_\_ and Temporary Guardrail Anchor Units Type \_\_\_* will be measured and paid as units of each completed and accepted. No separate measurement will be made of any rail, terminal sections, posts, offset blocks, concrete, hardware or any other components of the completed unit that are within the pay limits shown in the plans for the unit as all such components will be considered to be part of the unit.

Payment will be made under:

<b>Pay Item</b>	<b>Pay Unit</b>
Guardrail Anchor Units, Type ____	Each
Temporary Guardrail Anchor Units, Type ____	Each

**FOUNDATIONS AND ANCHOR ROD ASSEMBLIES FOR METAL POLES:**

(1-17-12) (Rev. 1-16-18)

9, 14, 17

SP9 R05

**Description**

Foundations for metal poles include foundations for signals, cameras, overhead and dynamic message signs (DMS) and high mount and light standards supported by metal poles or upright trusses. Foundations consist of footings with pedestals and drilled piers with or without grade beams or wings. Anchor rod assemblies consist of anchor rods (also called anchor bolts) with nuts and washers on the exposed ends of rods and nuts and a plate or washers on the other ends of rods embedded in the foundation.

Construct concrete foundations with the required resistances and dimensions and install anchor rod assemblies in accordance with the contract and accepted submittals. Construct drilled piers consisting of cast-in-place reinforced concrete cylindrical sections in excavated holes. Provide temporary casings or polymer slurry as needed to stabilize drilled pier excavations. Use a prequalified Drilled Pier Contractor to construct drilled piers for metal poles. Define “excavation” and “hole” as a drilled pier excavation and “pier” as a drilled pier.

This provision does not apply to foundations for signal pedestals; see Section 1743 of the *2018 Standard Specifications* and 2018 Roadway Standard Drawing No. 1743.01.

**Materials**

Refer to the *2018 Standard Specifications*.

<b>Item</b>	<b>Section</b>
Conduit	1091-3
Grout, Type 2	1003
Polymer Slurry	411-2(B)(2)
Portland Cement Concrete	1000
Reinforcing Steel	1070
Rollers and Chairs	411-2(C)
Temporary Casings	411-2(A)

Provide Type 3 material certifications in accordance with Article 106-3 of the *2018 Standard Specifications* for conduit, rollers, chairs and anchor rod assemblies. Store steel materials on blocking at least 12" above the ground and protect it at all times from damage; and when placing in the work make sure it is free from dirt, dust, loose mill scale, loose rust, paint, oil or other foreign materials. Load, transport, unload and store foundation and anchor rod assembly materials so materials are kept clean and free of damage. Bent, damaged or defective materials will be rejected.

Use conduit type in accordance with the contract. Use Class A concrete for footings and pedestals, Class Drilled Pier concrete for drilled piers and Class AA concrete for grade beams and wings including portions of drilled piers above bottom of wings elevations. Corrugated temporary casings may be accepted at the discretion of the Engineer. A list of approved polymer slurry products is available from:

[connect.ncdot.gov/resources/Geological/Pages/Products.aspx](http://connect.ncdot.gov/resources/Geological/Pages/Products.aspx)

Provide anchor rod assemblies in accordance with the contract consisting of the following:

- (A) Straight anchor rods,

- (B) Heavy hex top and leveling nuts and flat washers on exposed ends of rods, and
- (C) Nuts and either flat plates or washers on the other ends of anchor rods embedded in foundations.

Do not use lock washers. Use steel anchor rods, nuts and washers that meet ASTM F1554 for Grade 55 rods and Grade A nuts. Use steel plates and washers embedded in concrete with a thickness of at least 1/4". Galvanize anchor rods and exposed nuts and washers in accordance with Article 1076-4 of the *2018 Standard Specifications*. It is not necessary to galvanize nuts, plates and washers embedded in concrete.

### **Construction Methods**

Install the required size and number of conduits in foundations in accordance with the plans and accepted submittals. Construct top of piers, footings, pedestals, grade beams and wings flat, level and within 1" of elevations shown in the plans or approved by the Engineer. Provide an Ordinary Surface finish in accordance with Subarticle 825-6(B) of the *2018 Standard Specifications* for portions of foundations exposed above finished grade. Do not remove anchor bolt templates or pedestal or grade beam forms or erect metal poles or upright trusses onto foundations until concrete attains a compressive strength of at least 3,000 psi.

#### **(A) Drilled Piers**

Before starting drilled pier construction, hold a predrill meeting to discuss the installation, monitoring and inspection of the drilled piers. Schedule this meeting after the Drilled Pier Contractor has mobilized to the site. The Resident or Division Traffic Engineer, Contractor and Drilled Pier Contractor Superintendent will attend this predrill meeting.

Do not excavate holes, install piles or allow equipment wheel loads or vibrations within 20 ft of completed piers until 16 hours after Drilled Pier concrete reaches initial set.

Check for correct drilled pier alignment and location before beginning drilling. Check plumbness of holes frequently during drilling.

Construct drilled piers with the minimum required diameters shown in the plans. Install piers with tip elevations no higher than shown in the plans or approved by the Engineer.

Excavate holes with equipment of the sizes required to construct drilled piers. Depending on the subsurface conditions encountered, drilling through rock and boulders may be required. Do not use blasting for drilled pier excavations.

Contain and dispose of drilling spoils and waste concrete as directed and in accordance with Section 802 of the *2018 Standard Specifications*. Drilling spoils consist of all materials and fluids removed from excavations.

If unstable, caving or sloughing materials are anticipated or encountered, stabilize holes with temporary casings and/or polymer slurry. Do not use telescoping temporary casings. If it becomes necessary to replace a temporary casing during drilling, backfill the excavation, insert a larger casing around the casing to be replaced or stabilize the excavation with polymer slurry before removing the temporary casing.

If temporary casings become stuck or the Contractor proposes leaving casings in place, temporary casings should be installed against undisturbed material. Unless otherwise approved, do not leave temporary

casings in place for mast arm poles and cantilever signs. The Engineer will determine if casings may remain in place. If the Contractor proposes leaving temporary casings in place, do not begin drilling until a casing installation method is approved.

Use polymer slurry and additives to stabilize holes in accordance with the slurry manufacturer's recommendations. Provide mixing water and equipment suitable for polymer slurry. Maintain the required slurry properties at all times except for sand content.

Define a "sample set" as slurry samples collected from mid-height and within 2 ft of the bottom of holes. Take sample sets from excavations to test polymer slurry immediately after filling holes with slurry, at least every 4 hours thereafter and immediately before placing concrete. Do not place Drilled Pier concrete until both slurry samples from an excavation meet the required polymer slurry properties. If any slurry test results do not meet the requirements, the Engineer may suspend drilling until both samples from a sample set meet the required polymer slurry properties.

Remove soft and loose material from bottom of holes using augers to the satisfaction of the Engineer. Assemble rebar cages and place cages and Drilled Pier concrete in accordance with Subarticle 411-4(E) of the *2018 Standard Specifications* except for the following:

- (1) Inspections for tip resistance and bottom cleanliness are not required,
- (2) Temporary casings may remain in place if approved, and
- (3) Concrete placement may be paused near the top of pier elevations for anchor rod assembly installation and conduit placement or
- (4) If applicable, concrete placement may be stopped at bottom of grade beam or wings elevations for grade beam or wing construction.

If wet placement of concrete is anticipated or encountered, do not place Drilled Pier concrete until a concrete placement procedure is approved. If applicable, temporary casings and fluids may be removed when concrete placement is paused or stopped in accordance with the exceptions above provided holes are stable. Remove contaminated concrete from exposed Drilled Pier concrete after removing casings and fluids. If holes are unstable, do not remove temporary casings until a procedure for placing anchor rod assemblies and conduit or constructing grade beams or wings is approved.

Use collars to extend drilled piers above finished grade. Remove collars after Drilled Pier concrete sets and round top edges of piers.

If drilled piers are questionable, pile integrity testing (PIT) and further investigation may be required in accordance with Article 411-5 of the *2018 Standard Specifications*. A drilled pier will be considered defective in accordance with Subarticle 411-5(D) of the *2018 Standard Specifications* and drilled pier acceptance is based in part on the criteria in Article 411-6 of the *2018 Standard Specifications* except for the top of pier tolerances in Subarticle 411-6(C) of the *2018 Standard Specifications*.

If a drilled pier is under further investigation, do not grout core holes, backfill around the pier or perform any work on the drilled pier until the Engineer accepts the pier. If the drilled pier is accepted, dewater and grout core holes and backfill around the pier with approved material to finished grade. If the Engineer determines a pier is unacceptable, remediation is required in accordance with Article 411-6 of the *2018 Standard Specifications*. No extension of completion date or time will be allowed for remediation of unacceptable drilled piers or post repair testing.

Permanently embed a plate in or mark top of piers with the pier diameter and depth, size and number of vertical reinforcing bars and the minimum compressive strength of the concrete mix at 28 days.

(B) Footings, Pedestals, Grade Beams and Wings

Excavate as necessary for footings, grade beams and wings in accordance with the plans, accepted submittals and Section 410 of the *2018 Standard Specifications*. If unstable, caving or sloughing materials are anticipated or encountered, shore foundation excavations as needed with an approved method. Notify the Engineer when foundation excavation is complete. Do not place concrete or reinforcing steel until excavation dimensions and foundation material are approved.

Construct cast-in-place reinforced concrete footings, pedestals, grade beams and wings with the dimensions shown in the plans and in accordance with Section 825 of the *2018 Standard Specifications*. Use forms to construct portions of pedestals and grade beams protruding above finished grade. Provide a chamfer with a 3/4" horizontal width for pedestal and grade beam edges exposed above finished grade. Place concrete against undisturbed soil or backfill and fill in accordance with Article 410-8 of the *2018 Standard Specifications*. Proper compaction around footings and wings is critical for foundations to resist uplift and torsion forces.

(C) Anchor Rod Assemblies

Size anchor rods for design and the required projection above top of foundations. Determine required anchor rod projections from nut, washer and base plate thicknesses, the protrusion of 3 to 5 anchor rod threads above top nuts after tightening and the distance of one nut thickness between top of foundations and bottom of leveling nuts.

Protect anchor rod threads from damage during storage and installation of anchor rod assemblies. Before placing anchor rods in foundations, turn nuts onto and off rods past leveling nut locations. Turn nuts with the effort of one workman using an ordinary wrench without a cheater bar. Report any thread damage to the Engineer that requires extra effort to turn nuts.

Arrange anchor rods symmetrically about center of base plate locations as shown in the plans. Set anchor rod elevations based on required projections above top of foundations. Securely brace and hold rods in the correct position, orientation and alignment with a steel template. Do not weld to reinforcing steel, temporary casings or anchor rods.

Install top and leveling (bottom) nuts, washers and the base plate for each anchor rod assembly in accordance with the following procedure:

- (1) Turn leveling nuts onto anchor rods to a distance of one nut thickness between the top of foundation and bottom of leveling nuts. Place washers over anchor rods on top of leveling nuts.
- (2) Determine if nuts are level using a flat rigid template on top of washers. If necessary, lower leveling nuts to level the template in all directions or if applicable, lower nuts to tilt the template so the metal pole or upright truss will lean as shown in the plans. If leveling nuts and washers are not in full contact with the template, replace washers with galvanized beveled washers.
- (3) Verify the distance between the foundation and leveling nuts is no more than one nut thickness.
- (4) Place base plate with metal pole or upright truss over anchor rods on top of washers. High mount luminaires may be attached before erecting metal poles but do not attach cables, mast arms or trusses to metal poles or upright trusses at this time.
- (5) Place washers over anchor rods on top of base plate. Lubricate top nut bearing surfaces and exposed anchor rod threads above washers with beeswax, paraffin or other approved lubricant.
- (6) Turn top nuts onto anchor rods. If nuts are not in full contact with washers or washers are not in full contact with the base plate, replace washers with galvanized beveled washers.

- (7) Tighten top nuts to snug-tight with the full effort of one workman using a 12" wrench. Do not tighten any nut all at once. Turn top nuts in increments. Follow a star pattern cycling through each nut at least twice.
- (8) Repeat (7) for leveling nuts.
- (9) Replace washers above and below the base plate with galvanized beveled washers if the slope of any base plate face exceeds 1:20 (5%), any washer is not in firm contact with the base plate or any nut is not in firm contact with a washer. If any washers are replaced, repeat (7) and (8).
- (10) With top and leveling nuts snug-tight, mark each top nut on a corner at the intersection of 2 flats and a corresponding reference mark on the base plate. Mark top nuts and base plate with ink or paint that is  not  water-soluble. Use  the turn-of-nut method for pretensioning. Do not pretension any nut all at once. Turn top nuts in increments for a total turn that meets the following nut rotation requirements:

<b>NUT ROTATION REQUIREMENTS (Turn-of-Nut Pretensioning Method)</b>	
<b>Anchor Rod Diameter, inch</b>	<b>Requirement</b>
≤ 1 1/2	1/3 turn (2 flats)
> 1 1/2	1/6 turn (1 flat)

Follow a star pattern cycling through each top nut at least twice.

- (11) Ensure nuts, washers and base plate are in firm contact with each other for each anchor rod. Cables, mast arms and trusses may now be attached to metal poles and upright trusses.
- (12) Between 4 and 14 days after pretensioning top nuts, use a torque wrench calibrated within the last 12 months to check nuts in the presence of the Engineer. Completely erect mast arm poles and cantilever signs and attach any hardware before checking top nuts for these structures. Check that top nuts meet the following torque requirements:

<b>TORQUE REQUIREMENTS</b>	
<b>Anchor Rod Diameter, inch</b>	<b>Requirement, ft-lb</b>
7/8	180
1	270
1 1/8	380
1 1/4	420
≥ 1 1/2	600

If necessary, retighten top nuts in the presence of the Engineer with a calibrated torque wrench to within ± 10 ft-lb of the required torque. Do not overtighten top nuts.

- (13) Do not grout under base plate.

### **Measurement and Payment**

Foundations and anchor rod assemblies for metal poles and upright trusses will be measured and paid for elsewhere in the contract.

No payment will be made for temporary casings that remain in drilled pier excavations. No payment will be made for PIT. No payment will be made for further investigation of defective piers. Further investigation of piers that are not defective will be paid as extra work in accordance with Article 104-7 of the *2018 Standard Specifications*. No payment will be made for remediation of unacceptable drilled piers or post repair testing.

**PORTLAND CEMENT CONCRETE PRODUCTION AND DELIVERY:**

(9-15-20)

1000, 1014, 1024

SP10 R01

Revise the 2018 Standard Specifications as follows:

Page 10-6, Table 1000-1, REQUIREMENTS FOR CONCRETE, replace with the following:

TABLE 1000-1 REQUIREMENTS FOR CONCRETE											
Class of Concrete	Min. Compressive Strength at 28 days	Maximum Water-Cement Ratio				Consistency Maximum Slump		Cement Content			
		Air-Entrained Concrete		Non-Air- Entrained Concrete		Vibrated	Non- Vibrated	Vibrated		Non-Vibrated	
		Rounded Aggregate	Angular Aggregate	Rounded Aggregate	Angular Aggregate			Min.	Max.	Min.	Max.
		Units	psi					inch	inch	lb/cy	lb/cy
AA	4500	0.381	0.426	---	---	3.5 <sup>A</sup>	---	639	715	---	---
AA Slip Form	4500	0.381	0.426	---	---	1.5	---	639	715	---	---
Drilled Pier	4500	---	---	0.450	0.450	---	5 – 7 dry  7 - 9 wet	---	---	640	800
A	3000	0.488	0.532	0.550	0.594	3.5 <sup>A</sup>	4.0	564	---	602	---
B	2500	0.488	0.567	0.559	0.630	1.5 machine placed  2.5 <sup>A</sup> hand placed	4.0	508	---	545	---
Sand Light- weight	4500	---	0.420	---	---	4.0 <sup>A</sup>	---	715	---	---	---
Latex Modified	3000 (at 7 days)	0.400	0.400	---	---	6.0	---	658	---	---	---
Flowable Fill excavatable	150 max. (at 56 days)	as needed	as needed	as needed	as needed	---	Flowable	---	---	40	100
Flowable Fill non- excavatable	125	as needed	as needed	as needed	as needed	---	Flowable	---	---	100	as needed
Pavement	4500 Design, field	0.559	0.559	---	---	1.5 slip form	---	526	---	---	---
	650 flexural, design only										



Precast	See Table 1077-1	as needed	as needed	---	---	6.0	as needed	as needed	as needed	as needed	as needed
Prestressed	per contract	See Table 1078-1	See Table 1078-1	---	---	8.0	---	564	as needed	---	---

- A. The slump may be increased to 6 inches, provided the increase in slump is achieved by adding a chemical admixture conforming to Section 1024-3. In no case shall the water-cement ratio on the approved design be exceeded. Concrete exhibiting segregation and/or excessive bleeding will be rejected. Utilizing an Admixture to modify slump does not relinquish the contractor’s responsibility to ensure the final product quality and overall configuration meets design specifications. Caution should be taken when placing these modified mixes on steep grades to prevent unintended changes to the set slope.

**THERMOPLASTIC PAVEMENT MARKING MATERIAL – COLOR TESTING:**

3-19-19

1087

SP10 R05

Revise the *2018 Standard Specifications* as follows:

**Pages 10-183 and 10-184, Subarticle 1087-7(D)(1)(b) Yellow**, lines 9-11, delete and replace with the following:

Obtain Color Values Y,x,y per ASTM E1349 using C/2° illuminant/observer. Results shall be  $Y \geq 45\%$ , and x,y shall fall within PR#1 chart chromaticity limits.

**NON-CAST IRON SNOWPLOWABLE PAVEMENT MARKERS:**

10-19-21 (Rev. 11-16-21)

1086, 1250, 1253

SP10 R08

Revise the *2018 Standard Specifications* as follows:

**Pages 10-177 and 10-178, Subarticle 1086-3 SNOWPLOWABLE PAVEMENT MARKERS**, delete items (A), (B) and (C)(1) and replace with the following:

**(A) General**

Use non-cast iron snowplowable pavement markers evaluated by NTPEP. The non-cast iron snowplowable pavement marker shall consist of a housing with one or more glass or plastic face lens type reflective lenses to provide the required color designation. The marker shall be designed or installed in a manner that minimizes damage from snowplow blades. Plastic lens faces shall use an abrasion resistant coating.

**(B) Housings**

(1) Dimensions

The dimension, slope and minimum area of reflecting surface shall conform to dimensions as shown in the plans. The minimum area of each reflecting surface shall be 1.44 sq.in.

(2) Materials

Use non-cast iron snowplowable pavement markers that are on the NCDOT Approved Products List.

(3) Surface

The surface of the housing shall be free of scale, dirt, rust, oil, grease or any other contaminant which might reduce its bond to the epoxy adhesive.

(4) Identification

Mark the housing with the manufacturer's name and model number of marker.

**(C) Reflectors**

(1) General

Laminate the reflector to an elastomeric pad and attach with adhesive to the housing. The thickness of the elastomeric pad shall be 0.04".

**Pages 12-14, Subarticle 1250-3(C) Removal of Existing Pavement Markers, lines 19-29,** delete and replace with the following:

Remove the existing raised pavement markers or the snowplowable pavement markers including the housings, before overlaying an existing roadway with pavement. Repair the pavement by filling holes as directed by the Engineer.

When traffic patterns are changed in work zones due to construction or reconstruction, remove all raised pavement markers or snowplowable markers including housings that conflict with the new traffic pattern before switching traffic to the new traffic pattern. Lens removal in lieu of total housing removal is not an acceptable practice for snowplowable markers.

Properly dispose of the removed pavement markers. No direct payment will be made for removal or disposal of existing pavement markers or repair of pavement, as such work will be incidental to other items in the contract.

**Pages 12-16, Subarticle 1253-1 DESCRIPTION, lines 4-5,** delete and replace with the following:

Furnish, install and maintain non-cast iron snowplowable pavement markers in accordance with the contract.

**Pages 12-16 and 12-17, Subarticle 1253-3 CONSTRUCTION METHODS,** delete items (A), (B) and (C) and replace with the following:

**(A) General**

Bond marker housings to the pavement with epoxy adhesive. Mechanically mix and dispense epoxy adhesives as required by the manufacturer's specifications. Place the markers immediately after the adhesive has been mixed and dispensed.

If saw cutting, milling, or grooving operations are used, promptly remove all resulting debris from the pavement surface. Install the marker housings within 7 calendar days after saw

cutting, milling, or grooving the pavement. Remove and dispose of loose material from the slots by brushing, blow cleaning, or vacuuming. Dry the slots before applying the epoxy adhesive. Install non-cast iron snowplowable pavement markers according to the manufacturer's recommendations.

Protect the non-cast iron snowplowable pavement markers until the epoxy has initially cured and is track free.

**(B) Reflector Replacement**

In the event that a reflector is damaged, replace the damaged reflector by using adhesives and methods recommended by the manufacturer of the markers and approved by the Engineer. This work is considered incidental if damage occurs during the initial installation of the marker housings and maintenance of initial non-cast iron snowplowable markers specified in this section. This work will be paid for under the pay item for the type of reflector replacement if the damage occurred after the initial installation of the non-cast iron snowplowable pavement marker.

Missing housings shall be replaced. Broken housings shall be removed and replaced. In both cases the slot for the housings shall be properly prepared prior to installing the new housing; patch the existing marker slots as directed by the Engineer and install the new marker approximately one foot before or after the patch. Removal of broken housings and preparation of slots will be considered incidental to the work of replacing housings.

**Pages 12-17, Subarticle 1253-4 MAINTENANCE, lines 5,** delete and replace with the following:

Maintain all installed non-cast iron snowplowable pavement markers until acceptance.

**Pages 12-17, Subarticle 1253-5 MEASUREMENT AND PAYMENT, lines 7-8,** delete and replace with the following:

*Non-Cast Iron Snowplowable Pavement Markers* will be measured and paid as the actual number of non-cast iron snowplowable pavement markers satisfactorily placed and accepted by the Engineer.

**Pages 12-17, Subarticle 1253-5 MEASUREMENT AND PAYMENT, lines 11,** delete and replace with the following:

Payment will be made under:

<b>Pay Item</b>	<b>Pay Unit</b>
Non-Cast Iron Snowplowable Pavement Marker	Each
Replace Snowplowable Pavement Marker Reflector	Each

**MATERIALS FOR PORTLAND CEMENT CONCRETE:**

(9-15-20)

1000, 1024

SP10 R24

Revise the *2018 Standard Specifications* as follows:

**Page 10-52, Article 1024-4, WATER, lines 3-6,** delete and replace with the following:

Test water from wells at all locations. Test public water supplies from all out of state locations and in the following counties: Beaufort, Bertie, Brunswick, Camden, Carteret, Chowan, Craven, Currituck, Dare, Gates, Hyde, New Hanover, Onslow, Pamlico, Pasquotank, Pender, Perquimans, Tyrell and Washington unless the Engineer waives the testing requirements.

**Page 10-52, Table 1024-2, PHYSICAL PROPERTIES OF WATER,** replace with the following:

Property	Requirement	Test Method
Compression Strength, minimum percent of control at 3 and 7 days	90%	ASTM C1602
Time of set, deviation from control	From 1:00 hr. earlier to 1:30 hr. later	ASTM C1602
pH	4.5 to 8.5	ASTM D1293 *
Chloride Ion Content, Max.	250 ppm	ASTM D512 *
Total Solids Content (Residue), Max.	1,000 ppm	SM 2540B *
Resistivity, Min.	0.500 kohm-cm	ASTM D1125 *

\*Denotes an alternate method is acceptable. Test method used shall be referenced in the test report.

**MATERIAL AND EQUIPMENT STORAGE & PARKING OF PERSONAL VEHICLES:**

11-17-21

1101

SP11 R03

Revise the *2018 Standard Specifications* as follows:

**Page 11-2, Article 1101-8 MATERIAL AND EQUIPMENT STORAGE, line 35-38,** delete and replace with the following:

When work is not in progress, keep all personnel, equipment, machinery, tools, construction debris, materials and supplies away from active travel lanes that meets Table 1101-1.

TABLE 1101-1 MATERIAL AND EQUIPMENT STORAGE FROM ACTIVE TRAVEL LANES	
Posted Speed Limit (mph)	Distance (ft)
40 or less	≥ 18
45-50	≥ 28

55	$\geq 32$
60 or higher	$\geq 40$

When vehicles, equipment and materials are protected by concrete barrier or guardrail, they shall be offset at least 5 feet from the barrier or guardrail.

**Page 11-2, Article 1101-9 PARKING OF PERSONAL VEHICLES, line 40-41,** delete and replace with the following:

Provide staging areas for personal vehicle parking in accordance with section 1101-8 or as directed by the Engineer before use.



DocuSigned by:  
 Matthew V. Springer  
 BC60F6E8B584403...  
 1/27/2021

## **HOT SPRAY THERMOPLASTIC PAVEMENT MARKING LINES:**

12-01-20

### **Description**

This special provision covers machine applied “hot spray” thermoplastic pavement marking material with both incorporated glass beads and drop-on glass beads.

General, Color, Packing for Shipment, Storage, Materials, Construction Methods, Maintenance, Method of Measurement, and Basis of Payment shall be as described in Section 1087 and Section 1205 of the *Standard Specifications*, with the exceptions as shown below:

Revise the *2018 Standard Specifications* as follows:

**Page 10-182, Subarticle 1087-4(C) Gradation & Roundness**, lines 15-17, replace this subarticle with the following:

The glass beads used in all pavement marking shall be used according to the manufacturer’s recommendations in order to meet the retroreflectivity requirements as stated in Subarticles 1205-4(C) and 1205-4(D) as measured by any Department approved 30-meter geometry retroreflectivity device.

The glass beads shall be capable of flowing freely through dispensing equipment in any weather suitable for marking the pavement.

**Page 12-1, Subarticle 1205-2(B) Material Qualification**, line 9, add the following:

All “hot spray” thermoplastic manufacturers must be prequalified. In order to be prequalified, all “hot spray” Thermoplastic Pavement Marking manufacturers must have their material installed on the NTPEP test deck.

**Page 12-6, Subarticle 1205-4(A) Application Equipment**, delete lines 28-30, add the following:

Handliners shall not be allowed.

Use application equipment that provides multiple width settings ranging from 4” to 12” and multiple thickness settings to achieve a minimum 50 mil thickness in one pass.

**Page 12-7, Subarticle 1205-4(C) Application**, lines 2-5, delete the first paragraph and replace with the following:

All thermoplastic markings shall be of the hot, machine applied type. Application shall be accomplished by spraying methods only.

**Page 12-7, Subarticle 1205-4(C) Application**, lines 30-31, delete the last paragraph and replace with the following:

Produce a cross-sectional thickness of hot spray thermoplastic markings for long line markings only with a minimum thickness of 50 mils without glass beads and/or a minimum thickness of 55 mils with glass beads.

Extruded type thermoplastic shall not be sprayed.

The cross-sectional thickness of all “hot sprayed” thermoplastic markings above the surface of the existing pavement shall be no more than 60 mils.

The manufacturer of that material shall certify that the Contractor is trained to place the material. At least one member of each crew working on this project shall have completed this training. The Contractor shall furnish the Engineer written confirmation of this training from the material manufacturer prior to beginning the work.

If the hot sprayed thermoplastic is to be placed over milled-in rumble strips, the Contractor shall ensure that all debris is removed after milling and the surface is thoroughly cleaned to ensure optimum adhesion between the surface and the hot sprayed thermoplastic.

**Page 12-12, Article 1205-10 Measurement and Payment**, replace this article with the following:

Hot Spray Thermoplastic Pavement Marking Line, \_\_(width), \_\_(thickness) will be measured and paid as the actual number of linear feet of pavement marking lines satisfactorily placed and accepted by the Engineer. The quantity of solid lines will be the summation of the linear feet of solid line measured end-to-end of the line. The quantity of skip or broken lines will be the summation of the linear feet derived by multiplying the nominal length of a line by the number of marking lines satisfactorily placed. Such prices and payment will be full compensation for all work covered by this section including, but not limited to, furnishing, surface preparation, reapplication of molten pavement marking crossed by a vehicle, and removal of all pavement marking materials spilled on the roadway surface.

Payment will be made under:

<b>Pay Item</b>	<b>Pay Unit</b>
Hot Spray Thermoplastic Pavement Marking Lines, __, __	Linear Foot

**WORK ZONE INSTALLER:**

(7-20-21)

1101, 1150

SP11 R04

Provide the service of at least one qualified work zone installer during the setup, installation, and removal of temporary traffic control within the highway right of way. The qualified work zone installer shall serve as crew leader and shall be on site and directing the installation and removal of temporary traffic control. If multiple temporary traffic control installations or removals are occurring simultaneously, then each shall have a qualified work zone installer.

The work zone installer shall be qualified by an NCDOT approved training agency in the safe and competent set up of temporary traffic control. For a complete listing of approved training agencies, see the Work Zone Safety Training webpage.

A work zone supervisor, in accordance with Article 1101-13 of the *Standard Specifications*, may fulfill the role of the work zone installer during the setup, installation, and removal of temporary traffic control within the highway right of way provided they are on site and directing the installation and removal of temporary traffic control.

All other individuals participating in the setup, installation, and removal of temporary traffic control within the highway right of way shall be certified as a qualified flagger in accordance with Article 1150-3 of the *Standard Specifications*, even if flagging is not being performed as part of the traffic control.

Provide the name and contact information of all qualified work zone installers to the Engineer prior to or at the preconstruction conference. Additionally, provide a qualification statement that all other individuals participating in the setup, installation, and removal of temporary traffic control are qualified flaggers that have been properly trained through an NCDOT approved training agency.

**EXTRUDED THERMOPLASTIC PAVEMENT MARKING THICKNESS:**

3-19-19

1205

SP12 R05

Revise the 2018 *Standard Specifications* as follows:

**Page 12-6, Subarticle 1205-4(A)(1) General, lines 5-8,** delete the second sentence and replace with the following:

Use application equipment that provides multiple width settings ranging from 4 inches to 12 inches and multiple thickness settings to achieve a minimum pavement marking thickness of 0.090 inch above the surface of the pavement.

**Page 12-7, Table 1205-3, THICKNESS REQUIREMENTS FOR THERMOPLASTIC,** replace with the following:

<b>TABLE 1205-3 MINIMUM THICKNESS REQUIREMENTS FOR THERMOPLASTIC</b>	
<b>Thickness</b>	<b>Location</b>
240 mils	In-lane and shoulder-transverse pavement markings (rumble strips). May be placed in 2 passes.
90 mils	Center lines, skip lines, transverse bands, mini-skip lines, characters, bike lane symbols, crosswalk lines, edge lines, gore lines, diagonals, and arrow symbols



**STANDARD SPECIAL PROVISION**  
**AVAILABILITY OF FUNDS – TERMINATION OF CONTRACTS**

(5-20-08)

Z-2

*General Statute 143C-6-11. (h) Highway Appropriation* is hereby incorporated verbatim in this contract as follows:

(h) Amounts Encumbered. – Transportation project appropriations may be encumbered in the amount of allotments made to the Department of Transportation by the Director for the estimated payments for transportation project contract work to be performed in the appropriation fiscal year. The allotments shall be multiyear allotments and shall be based on estimated revenues and shall be subject to the maximum contract authority contained in *General Statute 143C-6-11(c)*. Payment for transportation project work performed pursuant to contract in any fiscal year other than the current fiscal year is subject to appropriations by the General Assembly. Transportation project contracts shall contain a schedule of estimated completion progress, and any acceleration of this progress shall be subject to the approval of the Department of Transportation provided funds are available. The State reserves the right to terminate or suspend any transportation project contract, and any transportation project contract shall be so terminated or suspended if funds will not be available for payment of the work to be performed during that fiscal year pursuant to the contract. In the event of termination of any contract, the contractor shall be given a written notice of termination at least 60 days before completion of scheduled work for which funds are available. In the event of termination, the contractor shall be paid for the work already performed in accordance with the contract specifications.

Payment will be made on any contract terminated pursuant to the special provision in accordance with Subarticle 108-13(D) of the *2018 Standard Specifications*.

**STANDARD SPECIAL PROVISION**  
**NCDOT GENERAL SEED SPECIFICATION FOR SEED QUALITY**

(5-17-11)

Z-3

Seed shall be sampled and tested by the North Carolina Department of Agriculture and Consumer Services, Seed Testing Laboratory. When said samples are collected, the vendor shall supply an independent laboratory report for each lot to be tested. Results from seed so sampled shall be final. Seed not meeting the specifications shall be rejected by the Department of Transportation and shall not be delivered to North Carolina Department of Transportation warehouses. If seed has been delivered it shall be available for pickup and replacement at the supplier’s expense.

Any re-labeling required by the North Carolina Department of Agriculture and Consumer Services, Seed Testing Laboratory, that would cause the label to reflect as otherwise specified herein shall be rejected by the North Carolina Department of Transportation.

Seed shall be free from seeds of the noxious weeds Johnsongrass, Balloonvine, Jimsonweed, Witchweed, Itchgrass, Serrated Tussock, Showy Crotalaria, Smooth Crotalaria, Sicklepod, Sandbur, Wild Onion, and Wild Garlic. Seed shall not be labeled with the above weed species on the seed analysis label. Tolerances as applied by the Association of Official Seed Analysts will NOT be allowed for the above noxious weeds except for Wild Onion and Wild Garlic.

Tolerances established by the Association of Official Seed Analysts will generally be recognized. However, for the purpose of figuring pure live seed, the found pure seed and found germination percentages as reported by the North Carolina Department of Agriculture and Consumer Services, Seed Testing Laboratory will be used. Allowances, as established by the NCDOT, will be recognized for minimum pure live seed as listed on the following pages.

The specifications for restricted noxious weed seed refers to the number per pound as follows:

<u>Restricted Noxious Weed</u>	<u>Limitations per Lb. Of Seed</u>	<u>Restricted Noxious Weed</u>	<u>Limitations per Lb. of Seed</u>
Blessed Thistle	4 seeds	Cornflower (Ragged Robin)	27 seeds
Cocklebur	4 seeds	Texas Panicum	27 seeds
Spurred Anoda	4 seeds	Bracted Plantain	54 seeds
Velvetleaf	4 seeds	Buckhorn Plantain	54 seeds
Morning-glory	8 seeds	Broadleaf Dock	54 seeds
Corn Cockle	10 seeds	Curly Dock	54 seeds
Wild Radish	12 seeds	Dodder	54 seeds
Purple Nutsedge	27 seeds	Giant Foxtail	54 seeds
Yellow Nutsedge	27 seeds	Horsenettle	54 seeds
Canada Thistle	27 seeds	Quackgrass	54 seeds
Field Bindweed	27 seeds	Wild Mustard	54 seeds
Hedge Bindweed	27 seeds		

Seed of Pensacola Bahiagrass shall not contain more than 7% inert matter, Kentucky Bluegrass, Centipede and Fine or Hard Fescue shall not contain more than 5% inert matter whereas a maximum of 2% inert matter will be allowed on all other kinds of seed. In addition, all seed shall not contain more than 2% other crop seed nor more than 1% total weed seed. The germination rate as tested by the North Carolina Department of Agriculture shall not fall below 70%, which includes both dormant and hard seed. Seed shall be labeled

with not more than 7%, 5% or 2% inert matter (according to above specifications), 2% other crop seed and 1% total weed seed.

Exceptions may be made for minimum pure live seed allowances when cases of seed variety shortages are verified. Pure live seed percentages will be applied in a verified shortage situation. Those purchase orders of deficient seed lots will be credited with the percentage that the seed is deficient.

FURTHER SPECIFICATIONS FOR EACH SEED GROUP ARE GIVEN BELOW:

Minimum 85% pure live seed; maximum 1% total weed seed; maximum 2% total other crop seed; maximum 144 restricted noxious weed seed per pound. Seed less than 83% pure live seed will not be approved.

Sericea Lespedeza  
Oats (seeds)

Minimum 80% pure live seed; maximum 1% total weed seed; maximum 2% total other crop; maximum 144 restricted noxious weed seed per pound. Seed less than 78% pure live seed will not be approved.

Tall Fescue (all approved varieties)	Bermudagrass
Kobe Lespedeza	Browntop Millet
Korean Lespedeza	German Millet – Strain R
Weeping Lovegrass	Clover – Red/White/Crimson
Carpetgrass	

Minimum 78% pure live seed; maximum 1% total weed seed; maximum 2% total other crop seed; maximum 144 restricted noxious weed seed per pound. Seed less than 76% pure live seed will not be approved.

Common or Sweet Sundangrass

Minimum 76% pure live seed; maximum 1% total weed seed; maximum 2% total other crop seed; maximum 144 restricted noxious weed seed per pound. Seed less than 74% pure live seed will not be approved.

Rye (grain; all varieties)  
Kentucky Bluegrass (all approved varieties)  
Hard Fescue (all approved varieties)  
Shrub (bicolor) Lespedeza

Minimum 70% pure live seed; maximum 1% total weed seed; maximum 2% total other crop seed; maximum 144 noxious weed seed per pound. Seed less than 70% pure live seed will not be approved.

Centipedegrass	Japanese Millet
Crownvetch	Reed Canary Grass
Pensacola Bahiagrass	Zoysia
Creeping Red Fescue	

Minimum 70% pure live seed; maximum 1% total weed seed; maximum 2% total other crop seed; maximum 5% inert matter; maximum 144 restricted noxious weed seed per pound.

Barnyard Grass  
Big Bluestem  
Little Bluestem

Bristly Locust  
Birdsfoot Trefoil  
Indiangrass  
Orchardgrass  
Switchgrass  
Yellow Blossom Sweet Clover

**STANDARD SPECIAL PROVISION****ERRATA**

(10-16-18) (Rev.1-18-22)

Z-4

Revise the *2018 Standard Specifications* as follows:

**Division 6**

**Page 6-7, Article 609-1 DESCRIPTION, line 29,** replace article number “609-10” with “609-9”.

**Division 7**

**Page 7-27, Article 725-1 MEASUREMENT AND PAYMENT, line 4,** replace article number “725-1” with “724-4”.

**Page 7-28, Article 725-1 MEASUREMENT AND PAYMENT, line 10,** replace article number “725-1” with “725-3”.

**Division 10**

**Page 10-78, Article 1056-4 GEOTEXTILES, TABLE 1056-1, Permittivity, Type 2,** replace “Table 6<sup>D</sup>” with “Table 7<sup>D</sup>” and **Permittivity, Type 3<sup>B</sup>,** replace “Table 7<sup>D</sup>” with “Table 8<sup>D</sup>”.

**Page 10-121, Article 1076-7, REPAIR OF GALVANIZING, line 8,** replace article number “1080-9” with “1080-7”.

**Page 10-162, Article 1080-50 PAINT FOR VERTICAL MARKERS, line 1,** replace article number “1080-50” with “1080-10”.

**Page 10-162, Article 1080-61 EPOXY RESIN FOR REINFORCING STEEL, line 5,** replace article number “1080-61” with “1080-11”.

**Page 10-162, Article 1080-72 ABRASIVE MATERIALS FOR BLAST CLEANING STEEL, line 22,** replace article number “1080-72” with “1080-12”.

**Page 10-163, Article 1080-83 FIELD PERFORMANCE AND SERVICES, line 25,** replace article number “1080-83” with “1080-13”.

**Division 17**

**Page 17-15, Article 1715-4 MEASUREMENT AND PAYMENT, lines 42-44,** replace the second sentence with the following:

An example is an installation of a single 1.25 inch HDPE conduit would be paid as:

Directional Drill (1)(1.25”) Linear Foot

**Page 17-15, Subarticle 1715-3(E) Bore and Jack, line 5,** replace article number “1540-4” with “1550-4”.

**Page 17-15, Subarticle 1715-3(E) Bore and Jack, lines 10 & 11,** replace "*NCDOT Policies and Procedures for Accommodating Utilities on Highway Rights of Way*" with "*NCDOT Utilities Accommodations Manual*".

**STANDARD SPECIAL PROVISION****PLANT AND PEST QUARANTINES**

**(Imported Fire Ant, Gypsy Moth, Witchweed, Emerald Ash Borer, Guava Root Knot Nematode, And Other Noxious Weeds)**

(3-18-03) (Rev. 5-21-19)

Z-04a

**Within Quarantined Area**

This project may be within a county regulated for plant and/or pests. If the project or any part of the Contractor's operations is located within a quarantined area, thoroughly clean all equipment prior to moving out of the quarantined area. Comply with federal/state regulations by obtaining a certificate or limited permit for any regulated article moving from the quarantined area.

**Originating in a Quarantined County**

Obtain a certificate or limited permit issued by the N.C. Department of Agriculture/United States Department of Agriculture. Have the certificate or limited permit accompany the article when it arrives at the project site.

**Contact**

Contact the N.C. Department of Agriculture/United States Department of Agriculture at 1-800-206-9333, 919-707-3730, or <https://www.ncagr.gov/plantindustry/Plant/quaran/table2.htm> to determine those specific project sites located in the quarantined area or for any regulated article used on this project originating in a quarantined county.

**Regulated Articles Include**

1. Soil, sand, gravel, compost, peat, humus, muck, and decomposed manure, separately or with other articles. This includes movement of articles listed above that may be associated with cut/waste, ditch pulling, and shoulder cutting.
2. Plants with roots including grass sod.
3. Plant crowns and roots.
4. Bulbs, corms, rhizomes, and tubers of ornamental plants.
5. Hay, straw, fodder, and plant litter of any kind.
6. Clearing and grubbing debris.
7. Used agricultural cultivating and harvesting equipment.
8. Used earth-moving equipment.
9. Any other products, articles, or means of conveyance, of any character, if determined by an inspector to present a hazard of spreading imported fire ant, gypsy moth, witchweed, emerald ash borer, guava root knot nematode, or other noxious weeds.

**STANDARD SPECIAL PROVISION****TITLE VI AND NONDISCRIMINATION:**

(6-28-77)(Rev 6/19/2018)

Z-6

Revise the *2018 Standard Specifications* as follows:

Replace Article 103-4(B) with the following:

The North Carolina Department of Transportation is committed to carrying out the U.S. Department of Transportation's policy of ensuring nondiscrimination in the award and administration of contracts.

The provisions of this section related to United States Department of Transportation (US DOT) Order 1050.2A, Title 49 Code of Federal Regulations (CFR) part 21, 23 United States Code (U.S.C.) 140 and 23 CFR part 200 (or 49 CFR 303, 49 U.S.C. 5332 or 49 U.S.C. 47123) are applicable to all North Carolina Department of Transportation (NCDOT) contracts and to all related subcontracts, material supply, engineering, architectural and other service contracts, regardless of dollar amount. Any Federal provision that is specifically required not specifically set forth is hereby incorporated by reference.

**(1) Title VI Assurances (USDOT Order 1050.2A, Appendix A)**

During the performance of this contract, the contractor, for itself, its assignees, and successors in interest (hereinafter referred to as the "contractor") agrees as follows:

**(a) Compliance with Regulations**

The contractor (hereinafter includes consultants) shall comply with the Acts and the Regulations relative to Nondiscrimination in Federally-assisted programs of the U.S. Department of Transportation, Federal Highway Administration (FHWA), as they may be amended from time to time, which are herein incorporated by reference and made a part of this contract.

**(b) Nondiscrimination**

The contractor, with regard to the work performed by it during the contract, shall not discriminate on the grounds of race, color, or national origin in the selection and retention of subcontractors, including procurements of materials and leases of equipment. The contractor shall not participate directly or indirectly in the discrimination prohibited by the Acts and the Regulations, including employment practices when the contract covers any activity, project, or program set forth in Appendix B of 49 CFR Part 21.

**(c) Solicitations for Subcontractors, Including Procurements of Materials and Equipment**

In all solicitations, either by competitive bidding, or negotiation made by the contractor for work to be performed under a subcontract, including procurements of materials, or leases of equipment, each potential subcontractor or supplier shall be notified by the contractor of the contractor's obligations under this contract and the Acts and the Regulations relative to Nondiscrimination on the grounds of race, color, or national origin.

**(d) Information and Reports**

The contractor shall provide all information and reports required by the Acts, the Regulations, and directives issued pursuant thereto and shall permit access to its books, records, accounts, other sources of information, and its facilities as may be determined by the Recipient or the FHWA to be pertinent to ascertain compliance with such Acts, Regulations, and instructions. Where any information required of a contractor is in the exclusive possession of another who fails or refuses to furnish the information, the contractor shall so certify to the Recipient or the FHWA, as appropriate, and shall set forth what efforts it has made to obtain the information.

**(e) Sanctions for Noncompliance:**



In the event of a contractor's noncompliance with the Non-discrimination provisions of this contract, the Recipient will impose such contract sanctions as it and/or the FHWA may determine to be appropriate, including, but not limited to:

- (i) Withholding payments to the contractor under the contract until the contractor complies; and/or
  - (ii) Cancelling, terminating, or suspending a contract, in whole or in part.
- (f) Incorporation of Provisions

The contractor shall include the provisions of paragraphs (a) through (f) in every subcontract, including procurements of materials and leases of equipment, unless exempt by the Acts, the Regulations and directives issued pursuant thereto. The contractor shall take action with respect to any subcontract or procurement as the Recipient or the FHWA may direct as a means of enforcing such provisions including sanctions for noncompliance. Provided, that if the contractor becomes involved in, or is threatened with litigation by a subcontractor, or supplier because of such direction, the contractor may request the Recipient to enter into any litigation to protect the interests of the Recipient. In addition, the contractor may request the United States to enter into the litigation to protect the interests of the United States.

**(2) Title VI Nondiscrimination Program (23 CFR 200.5(p))**

The North Carolina Department of Transportation (NCDOT) has assured the USDOT that, as a condition to receiving federal financial assistance, NCDOT will comply with Title VI of the Civil Rights Act of 1964 and all requirements imposed by Title 49 CFR part 21 and related nondiscrimination authorities to ensure that no person shall, on the ground of race, color, national origin, limited English proficiency, sex, age, or disability (including religion/creed or income-level, where applicable), be excluded from participation in, be denied the benefits of, or be subjected to discrimination under any programs, activities, or services conducted or funded by NCDOT. Contractors and other organizations under contract or agreement with NCDOT must also comply with Title VI and related authorities, therefore:

- (a) During the performance of this contract or agreement, contractors (e.g., subcontractors, consultants, vendors, prime contractors) are responsible for complying with NCDOT's Title VI Program. Contractors are not required to prepare or submit Title VI Programs. To comply with this section, the prime contractor shall:
  1. Post NCDOT's Notice of Nondiscrimination and the Contractor's own Equal Employment Opportunity (EEO) Policy in conspicuous locations accessible to all employees, applicants and subcontractors on the jobsite.
  2. Physically incorporate the required Title VI clauses into all subcontracts on federally-assisted and state-funded NCDOT projects, and ensure inclusion by subcontractors into all lower-tier subcontracts.
  3. Required Solicitation Language. The Contractor shall include the following notification in all solicitations for bids and requests for work or material, regardless of funding source:

“The North Carolina Department of Transportation, in accordance with the provisions of Title VI of the Civil Rights Act of 1964 (78 Stat. 252, 42 U.S.C. §§ 2000d to 2000d-4) and the Regulations, hereby notifies all bidders that it will affirmatively ensure that any contract entered into pursuant to this advertisement, disadvantaged business enterprises will be afforded full and fair opportunity to submit bids in response to this invitation and will not be discriminated against on the grounds of race, color, or national origin in consideration for an award. In accordance with other related nondiscrimination authorities, bidders and contractors will also not be discriminated against on the grounds of sex, age, disability, low-income level, creed/religion, or limited English proficiency in consideration for an award.”

4. Physically incorporate the FHWA-1273, in its entirety, into all subcontracts and subsequent lower tier subcontracts on Federal-aid highway construction contracts only.
  5. Provide language assistance services (i.e., written translation and oral interpretation), free of charge, to LEP employees and applicants. Contact NCDOT OCR for further assistance, if needed.
  6. For assistance with these Title VI requirements, contact the NCDOT Title VI Nondiscrimination Program at 1-800-522-0453.
- (b) Subrecipients (e.g. cities, counties, LGAs, planning organizations) may be required to prepare and submit a Title VI Plan to NCDOT, including Title VI Assurances and/or agreements. Subrecipients must also ensure compliance by their contractors and subrecipients with Title VI. (23 CFR 200.9(b)(7))
- (c) If reviewed or investigated by NCDOT, the contractor or subrecipient agrees to take affirmative action to correct any deficiencies found within a reasonable time period, not to exceed 90 calendar days, unless additional time is granted by NCDOT. (23 CFR 200.9(b)(15))
- (d) The Contractor is responsible for notifying subcontractors of NCDOT's External Discrimination Complaints Process.
1. **Applicability**  
Title VI and related laws protect participants and beneficiaries (e.g., members of the public and contractors) from discrimination by NCDOT employees, subrecipients and contractors, regardless of funding source.
  2. **Eligibility**  
Any person—or class of persons—who believes he/she has been subjected to discrimination based on race, color, national origin, Limited English Proficiency (LEP), sex, age, or disability (and religion in the context of employment, aviation, or transit) may file a written complaint. The law also prohibits intimidation or retaliation of any sort.
  3. **Time Limits and Filing Options**  
Complaints may be filed by the affected individual(s) or a representative and must be filed no later than 180 calendar days after the following:
    - (i) The date of the alleged act of discrimination; or
    - (ii) The date when the person(s) became aware of the alleged discrimination; or
    - (iii) Where there has been a continuing course of conduct, the date on which that conduct was discontinued or the latest instance of the conduct.Title VI and related discrimination complaints may be submitted to the following entities:
    - North Carolina Department of Transportation, Office of Civil Rights, Title VI Program, 1511 Mail Service Center, Raleigh, NC 27699-1511; toll free 1-800-522-0453
    - Federal Highway Administration, North Carolina Division Office, 310 New Bern Avenue, Suite 410, Raleigh, NC 27601, 919-747-7010
    - US Department of Transportation, Departmental Office of Civil Rights, External Civil Rights Programs Division, 1200 New Jersey Avenue, SE, Washington, DC 20590; 202-366-4070
  4. **Format for Complaints**  
Complaints must be in writing and signed by the complainant(s) or a representative, and include the complainant's name, address, and telephone number. Complaints received by fax or e-mail will be acknowledged and processed. Allegations received by telephone will be reduced to writing and provided to the complainant for confirmation or revision before processing. Complaints will be accepted in other languages, including Braille.
  5. **Discrimination Complaint Form**  
Contact NCDOT Civil Rights to receive a full copy of the Discrimination Complaint Form and procedures.

6. Complaint Basis

Allegations must be based on issues involving race, color, national origin (LEP), sex, age, disability, or religion (in the context of employment, aviation or transit). “Basis” refers to the complainant’s membership in a protected group category.

**TABLE 103-1  
COMPLAINT BASIS**

Protected Categories	Definition	Examples	Applicable Nondiscrimination Authorities
Race and Ethnicity	An individual belonging to one of the accepted racial groups; or the perception, based usually on physical characteristics that a person is a member of a racial group	Black/African American, Hispanic/Latino, Asian, American Indian/Alaska Native, Native Hawaiian/Pacific Islander, White	Title VI of the Civil Rights Act of 1964; 49 CFR Part 21; 23 CFR 200; 49 U.S.C. 5332(b); 49 U.S.C. 47123. <i>(Executive Order 13166)</i>
Color	Color of skin, including shade of skin within a racial group	Black, White, brown, yellow, etc.	
National Origin <i>(Limited English Proficiency)</i>	Place of birth. Citizenship is not a factor. <i>(Discrimination based on language or a person’s accent is also covered)</i>	Mexican, Cuban, Japanese, Vietnamese, Chinese	
Sex	Gender. The sex of an individual. <i>Note: Sex under this program does not include sexual orientation.</i>	Women and Men	1973 Federal-Aid Highway Act; 49 U.S.C. 5332(b); 49 U.S.C. 47123.
Age	Persons of any age	21-year-old person	Age Discrimination Act of 1975 49 U.S.C. 5332(b); 49 U.S.C. 47123.
Disability	Physical or mental impairment, permanent or temporary, or perceived.	Blind, alcoholic, para-amputee, epileptic, diabetic, arthritic	Section 504 of the Rehabilitation Act of 1973; Americans with Disabilities Act of 1990
Religion (in the context of employment) <i>(Religion/ Creed in all aspects of any aviation or transit-related construction)</i>	An individual belonging to a religious group; or the perception, based on distinguishable characteristics that a person is a member of a religious group. In practice, actions taken as a result of the moral and ethical beliefs as to what is right and wrong, which are sincerely held with the strength of traditional religious views. <i>Note: Does not have to be associated with a recognized religious group or church; if an individual sincerely holds to the belief, it is a protected religious practice.</i>	Muslim, Christian, Sikh, Hindu, etc.	Title VII of the Civil Rights Act of 1964; 23 CFR 230; FHWA-1273 Required Contract Provisions. <i>(49 U.S.C. 5332(b); 49 U.S.C. 47123)</i>

**(3) Pertinent Nondiscrimination Authorities**

During the performance of this contract, the contractor, for itself, its assignees, and successors in interest agrees to comply with the following non-discrimination statutes and authorities, including, but not limited to:

- (a) Title VI of the Civil Rights Act of 1964 (42 U.S.C. § 2000d et seq., 78 stat. 252), (prohibits discrimination on the basis of race, color, national origin); and 49 CFR Part 21.
- (b) The Uniform Relocation Assistance and Real Property Acquisition Policies Act of 1970, (42 U.S.C. § 4601), (prohibits unfair treatment of persons displaced or whose property has been acquired because of Federal or Federal-aid programs and projects);
- (c) Federal-Aid Highway Act of 1973, (23 U.S.C. § 324 et seq.), (prohibits discrimination on the basis of sex);
- (d) Section 504 of the Rehabilitation Act of 1973, (29 U.S.C. § 794 et seq.), as amended, (prohibits discrimination on the basis of disability) and 49 CFR Part 27;
- (e) The Age Discrimination Act of 1975, as amended, (42 U.S.C. § 6101 et seq.), (prohibits discrimination on the basis of age);
- (f) Airport and Airway Improvement Act of 1982, (49 USC § 471, Section 47123), as amended, (prohibits discrimination based on race, creed, color, national origin, or sex);
- (g) The Civil Rights Restoration Act of 1987, (PL 100-209), (Broadened the scope, coverage and applicability of Title VI of the Civil Rights Act of 1964, The Age Discrimination Act of 1975 and Section 504 of the Rehabilitation Act of 1973, by expanding the definition of the terms "programs or activities" to include all of the programs or activities of the Federal-aid recipients, sub-recipients and contractors, whether such programs or activities are Federally funded or not);
- (h) Titles II and III of the Americans with Disabilities Act, which prohibit discrimination on the basis of disability in the operation of public entities, public and private transportation systems, places of public accommodation, and certain testing entities (42 U.S.C. §§ 12131-12189) as implemented by Department of Transportation regulations at 49 C.F.R. parts 37 and 38;
- (i) The Federal Aviation Administration's Nondiscrimination statute (49 U.S.C. § 47123) (prohibits discrimination on the basis of race, color, national origin, and sex);
- (j) Executive Order 12898, Federal Actions to Address Environmental Justice in Minority Populations and Low-Income Populations, which ensures Nondiscrimination against minority populations by discouraging programs, policies, and activities with disproportionately high and adverse human health or environmental effects on minority and low-income populations;
- (k) Executive Order 13166, Improving Access to Services for Persons with Limited English Proficiency, and resulting agency guidance, national origin discrimination includes discrimination because of Limited English proficiency (LEP). To ensure compliance with Title VI, you must take reasonable steps to ensure that LEP persons have meaningful access to your programs (70 Fed. Reg. at 74087 to 74100);
- (l) Title IX of the Education Amendments of 1972, as amended, which prohibits you from discriminating because of sex in education programs or activities (20 U.S.C. 1681 et seq).
- (m) Title VII of the Civil Rights Act of 1964 (42 U.S.C. § 2000e et seq., Pub. L. 88-352), (prohibits employment discrimination on the basis of race, color, religion, sex, or national origin).

**(4) Additional Title VI Assurances**

*\*\*The following Title VI Assurances (Appendices B, C and D) shall apply, as applicable*

- (a) Clauses for Deeds Transferring United States Property (1050.2A, Appendix B)  
The following clauses will be included in deeds effecting or recording the transfer of real property, structures, or improvements thereon, or granting interest therein from the United States pursuant to the provisions of Assurance 4.

NOW, THEREFORE, the U.S. Department of Transportation as authorized by law and upon the condition that the North Carolina Department of Transportation (NCDOT) will accept title to the lands and maintain the project constructed thereon in accordance with the North Carolina General Assembly, the Regulations for the Administration of the Federal-Aid Highway Program, and the policies and procedures prescribed by the Federal Highway Administration of the U.S. Department of Transportation in accordance and in compliance with all requirements imposed by Title 49, Code of Federal Regulations, U.S. Department of Transportation, Subtitle A, Office of the Secretary, Part 21, Nondiscrimination in Federally-assisted programs of the U.S. Department of Transportation pertaining to and effectuating the provisions of Title VI of the Civil Rights Act of 1964 (78 Stat. 252; 42 U.S.C. § 2000d to 2000d-4), does hereby remise, release, quitclaim and convey unto the NCDOT all the right, title and interest of the U.S. Department of Transportation in and to said lands described in Exhibit A attached hereto and made a part hereof.

(HABENDUM CLAUSE)

TO HAVE AND TO HOLD said lands and interests therein unto the North Carolina Department of Transportation (NCDOT) and its successors forever, subject, however, to the covenants, conditions, restrictions and reservations herein contained as follows, which will remain in effect for the period during which the real property or structures are used for a purpose for which Federal financial assistance is extended or for another purpose involving the provision of similar services or benefits and will be binding on the NCDOT, its successors and assigns.

The NCDOT, in consideration of the conveyance of said lands and interests in lands, does hereby covenant and agree as a covenant running with the land for itself, its successors and assigns, that (1) no person will on the grounds of race, color, or national origin, be excluded from participation in, be denied the benefits of, or be otherwise subjected to discrimination with regard to any facility located wholly or in part on, over, or under such lands hereby conveyed [,] [and]\* (2) that the NCDOT will use the lands and interests in lands and interests in lands so conveyed, in compliance with all requirements imposed by or pursuant to Title 49, Code of Federal Regulations, U.S. Department of Transportation, Subtitle A, Office of the Secretary, Part 21, Non-discrimination in Federally-assisted programs of the U.S. Department of Transportation, Effectuation of Title VI of the Civil Rights Act of 1964, and as said Regulations and Acts may be amended [, and (3) that in the event of breach of any of the above-mentioned nondiscrimination conditions, the Department will have a right to enter or re-enter said lands and facilities on said land, and that above described land and facilities will thereon revert to and vest in and become the absolute property of the U.S. Department of Transportation and its assigns as such interest existed prior to this instruction].\*

(\*Reverter clause and related language to be used only when it is determined that such a clause is necessary in order to make clear the purpose of Title VI.)

- (b) Clauses for Transfer of Real Property Acquired or Improved Under the Activity, Facility, or Program (1050.2A, Appendix C)

The following clauses will be included in deeds, licenses, leases, permits, or similar instruments entered into by the North Carolina Department of Transportation (NCDOT) pursuant to the provisions of Assurance 7(a):

1. The (grantee, lessee, permittee, etc. as appropriate) for himself/herself, his/her heirs, personal representatives, successors in interest, and assigns, as a part of the consideration hereof, does hereby covenant and agree [in the case of deeds and leases add "as a covenant running with the land"] that:

- (i.) In the event facilities are constructed, maintained, or otherwise operated on the property described in this (deed, license, lease, permit, etc.) for a purpose for which a U.S. Department of Transportation activity, facility, or program is extended or for another purpose involving the provision of similar services or benefits, the (grantee, licensee, lessee, permittee, etc.) will maintain and operate such facilities and services in compliance with all requirements imposed by the Acts and Regulations (as may be amended) such that no person on the grounds of race, color, or national origin, will be excluded from participation in, denied the benefits of, or be otherwise subjected to discrimination in the use of said facilities.
2. With respect to licenses, leases, permits, etc., in the event of breach of any of the above Nondiscrimination covenants, the NCDOT will have the right to terminate the (lease, license, permit, etc.) and to enter, re-enter, and repossess said lands and facilities thereon, and hold the same as if the (lease, license, permit, etc.) had never been made or issued. \*
3. With respect to a deed, in the event of breach of any of the above Nondiscrimination covenants, the NCDOT will have the right to enter or re-enter the lands and facilities thereon, and the above described lands and facilities will there upon revert to and vest in and become the absolute property of the NCDOT and its assigns. \*

(\*Reverter clause and related language to be used only when it is determined that such a clause is necessary to make clear the purpose of Title VI.)

(c) Clauses for Construction/Use/Access to Real Property Acquired Under the Activity, Facility or Program (1050.2A, Appendix D)

The following clauses will be included in deeds, licenses, permits, or similar instruments/agreements entered into by the North Carolina Department of Transportation (NCDOT) pursuant to the provisions of Assurance 7(b):

1. The (grantee, licensee, permittee, etc., as appropriate) for himself/herself, his/her heirs, personal representatives, successors in interest, and assigns, as a part of the consideration hereof, does hereby covenant and agree (in the case of deeds and leases add, "as a covenant running with the land") that (1) no person on the ground of race, color, or national origin, will be excluded from participation in, denied the benefits of, or be otherwise subjected to discrimination in the use of said facilities, (2) that in the construction of any improvements on, over, or under such land, and the furnishing of services thereon, no person on the ground of race, color, or national origin, will be excluded from participation in, denied the benefits of, or otherwise be subjected to discrimination, (3) that the (grantee, licensee, lessee, permittee, etc.) will use the premises in compliance with all other requirements imposed by or pursuant to the Acts and Regulations, as amended, set forth in this Assurance.
2. With respect to (licenses, leases, permits, etc.), in the event of breach of any of the above Non-discrimination covenants, the NCDOT will have the right to terminate the (license, permit, etc., as appropriate) and to enter or re-enter and repossess said land and the facilities thereon, and hold the same as if said (license, permit, etc., as appropriate) had never been made or issued. \*
3. With respect to deeds, in the event of breach of any of the above Nondiscrimination covenants, the NCDOT will there upon revert to and vest in and become the absolute property of the NCDOT and its assigns. \*

(\*Reverter clause and related language to be used only when it is determined that such a clause is necessary to make clear the purpose of Title VI.)

**STANDARD SPECIAL PROVISION****MINORITY AND FEMALE EMPLOYMENT REQUIREMENTS**

Z-7

**NOTICE OF REQUIREMENTS FOR AFFIRMATIVE ACTION TO ENSURE EQUAL EMPLOYMENT OPPORTUNITY (*EXECUTIVE NUMBER 11246*)**

1. The goals and timetables for minority and female participation, expressed in percentage terms for the Contractor's aggregate workforce in each trade on all construction work in the covered area, see as shown on the attached sheet entitled "Employment Goals for Minority and Female participation".

These goals are applicable to all the Contractor's construction work (whether or not it is Federal or federally assisted) performed in the covered area. If the Contractor performs construction work in a geographical area located outside of the covered area, it shall apply the goals established for such geographical area where the work is actually performed. With regard to this second area, the Contractor also is subject to the goals for both its federally involved and nonfederally involved construction.

The Contractor's compliance with the Executive Order and the regulations in *41 CFR Part 60-4* shall be based on its implementation of the Equal Opportunity Clause, specific affirmative action obligations required by the specifications set forth in *41 CFR 60-4.3(a)*, and its effort to meet the goals. The hours of minority and female employment and training must be substantially uniform throughout the length of the contract, and in each trade and the Contractor shall make a good faith effort to employ minorities and women evenly on each of its projects. The transfer of minority or female employees or trainees from Contractor to Contractor or from project to project for the sole purpose of meeting the Contractor's goals shall be a violation of the contract, the executive Order and the regulations in *41 CFR Part 60-4*. Compliance with the goals will be measured against the total work hours performed.

2. As used in this Notice and in the contract resulting from this solicitation, the "covered area" is the county or counties shown on the cover sheet of the proposal form and contract.

**EMPLOYMENT GOALS FOR MINORITY  
AND FEMALE PARTICIPATION**

Economic Areas

**Area 023 29.7%**

Bertie County  
Camden County  
Chowan County  
Gates County  
Hertford County  
Pasquotank County  
Perquimans County

**Area 024 31.7%**

Beaufort County  
Carteret County  
Craven County  
Dare County  
Edgecombe County  
Green County  
Halifax County  
Hyde County  
Jones County  
Lenoir County  
Martin County  
Nash County  
Northampton County  
Pamlico County  
Pitt County  
Tyrrell County  
Washington County  
Wayne County  
Wilson County

**Area 025 23.5%**

Columbus County  
Duplin County  
Onslow County  
Pender County

**Area 026 33.5%**

Bladen County  
Hoke County  
Richmond County  
Robeson County  
Sampson County  
Scotland County

**Area 027 24.7%**

Chatham County  
Franklin County  
Granville County  
Harnett County  
Johnston County  
Lee County  
Person County  
Vance County  
Warren County

**Area 028 15.5%**

Alleghany County  
Ashe County  
Caswell County  
Davie County  
Montgomery County  
Moore County  
Rockingham County  
Surry County  
Watauga County  
Wilkes County

**Area 029 15.7%**

Alexander County  
Anson County  
Burke County  
Cabarrus County  
Caldwell County  
Catawba County  
Cleveland County  
Iredell County  
Lincoln County  
Polk County  
Rowan County  
Rutherford County  
Stanly County

**Area 0480 8.5%**

Buncombe County  
Madison County

**Area 030 6.3%**

Avery County  
Cherokee County  
Clay County  
Graham County  
Haywood County  
Henderson County  
Jackson County  
McDowell County  
Macon County  
Mitchell County  
Swain County  
Transylvania County  
Yancey County



SMSA Areas

Area 5720 26.6%

Currituck County

Area 9200 20.7%

Brunswick County

New Hanover County

Area 2560 24.2%

Cumberland County

Area 6640 22.8%

Durham County

Orange County

Wake County

Area 1300 16.2%

Alamance County

Area 3120 16.4%

Davidson County

Forsyth County

Guilford County

Randolph County

Stokes County

Yadkin County

Area 1520 18.3%

Gaston County

Mecklenburg County

Union County

---

Goals for Female

Participation in Each Trade

(Statewide) 6.9%

**STANDARD SPECIAL PROVISION****REQUIRED CONTRACT PROVISIONS FEDERAL - AID CONSTRUCTION CONTRACTS**

FHWA - 1273 Electronic Version - May 1, 2012

Z-8

- I. General
- II. Nondiscrimination
- III. Nonsegregated Facilities
- IV. Davis-Bacon and Related Act Provisions
- V. Contract Work Hours and Safety Standards Act Provisions
- VI. Subletting or Assigning the Contract
- VII. Safety: Accident Prevention
- VIII. False Statements Concerning Highway Projects
- IX. Implementation of Clean Air Act and Federal Water Pollution Control Act
- X. Compliance with Governmentwide Suspension and Debarment Requirements
- XI. Certification Regarding Use of Contract Funds for Lobbying

**ATTACHMENTS**

- A. Employment and Materials Preference for Appalachian Development Highway System or Appalachian Local Access Road Contracts (included in Appalachian contracts only)

**I. GENERAL**

1. Form FHWA-1273 must be physically incorporated in each construction contract funded under Title 23 (excluding emergency contracts solely intended for debris removal). The contractor (or subcontractor) must insert this form in each subcontract and further require its inclusion in all lower tier subcontracts (excluding purchase orders, rental agreements and other agreements for supplies or services).  
The applicable requirements of Form FHWA-1273 are incorporated by reference for work done under any purchase order, rental agreement or agreement for other services. The prime contractor shall be responsible for compliance by any subcontractor, lower-tier subcontractor or service provider.  
Form FHWA-1273 must be included in all Federal-aid design-build contracts, in all subcontracts and in lower tier subcontracts (excluding subcontracts for design services, purchase orders, rental agreements and other agreements for supplies or services). The design-builder shall be responsible for compliance by any subcontractor, lower-tier subcontractor or service provider.  
Contracting agencies may reference Form FHWA-1273 in bid proposal or request for proposal documents, however, the Form FHWA-1273 must be physically incorporated (not referenced) in all contracts, subcontracts and lower-tier subcontracts (excluding purchase orders, rental agreements and other agreements for supplies or services related to a construction contract).
2. Subject to the applicability criteria noted in the following sections, these contract provisions shall apply to all work performed on the contract by the contractor's own organization and with the assistance of workers under the contractor's immediate superintendence and to all work performed on the contract by piecework, station work, or by subcontract.
3. A breach of any of the stipulations contained in these Required Contract Provisions may be sufficient grounds for withholding of progress payments, withholding of final payment, termination of the contract, suspension / debarment or any other action determined to be appropriate by the contracting agency and FHWA.
4. Selection of Labor: During the performance of this contract, the contractor shall not use convict labor for any purpose within the limits of a construction project on a Federal-aid highway unless it is labor performed by convicts who are on parole, supervised release, or probation. The term Federal-aid highway does not include roadways functionally classified as local roads or rural minor collectors.

**II. NONDISCRIMINATION**

The provisions of this section related to 23 CFR Part 230 are applicable to all Federal-aid construction contracts and to all related construction subcontracts of \$10,000 or more. The provisions of 23 CFR Part 230 are not applicable to material supply, engineering, or architectural service contracts.

In addition, the contractor and all subcontractors must comply with the following policies: Executive Order 11246, 41 CFR 60, 29 CFR 1625-1627, Title 23 USC Section 140, the Rehabilitation Act of 1973, as amended (29 USC 794), Title VI of the Civil Rights Act of 1964, as amended, and related regulations including 49 CFR Parts 21, 26 and 27; and 23 CFR Parts 200, 230, and 633.

The contractor and all subcontractors must comply with: the requirements of the Equal Opportunity Clause in 41 CFR 60-1.4(b) and, for all construction contracts exceeding \$10,000, the Standard Federal Equal Employment Opportunity Construction Contract Specifications in 41 CFR 60-4.3.

Note: The U.S. Department of Labor has exclusive authority to determine compliance with Executive Order 11246 and the policies of the Secretary of Labor including 41 CFR 60, and 29 CFR 1625-1627. The contracting agency and the FHWA have the authority and the responsibility to ensure compliance with Title 23 USC Section 140, the Rehabilitation Act of 1973, as amended (29 USC 794), and Title VI of the Civil Rights Act of 1964, as amended, and related regulations including 49 CFR Parts 21, 26 and 27; and 23 CFR Parts 200, 230, and 633.

The following provision is adopted from 23 CFR 230, Appendix A, with appropriate revisions to conform to the U.S. Department of Labor (US DOL) and FHWA requirements.

1. **Equal Employment Opportunity:** Equal employment opportunity (EEO) requirements not to discriminate and to take affirmative action to assure equal opportunity as set forth under laws, executive orders, rules, regulations (28 CFR 35, 29 CFR 1630, 29 CFR 1625-1627, 41 CFR 60 and 49 CFR 27) and orders of the Secretary of Labor as modified by the provisions prescribed herein, and imposed pursuant to 23 U.S.C. 140 shall constitute the EEO and specific affirmative action standards for the contractor's project activities under this contract. The provisions of the Americans with Disabilities Act of 1990 (42 U.S.C. 12101 et seq.) set forth under 28 CFR 35 and 29 CFR 1630 are incorporated by reference in this contract. In the execution of this contract, the contractor agrees to comply with the following minimum specific requirement activities of EEO:

- a. The contractor will work with the contracting agency and the Federal Government to ensure that it has made every good faith effort to provide equal opportunity with respect to all of its terms and conditions of employment and in their review of activities under the contract.
- b. The contractor will accept as its operating policy the following statement:  
"It is the policy of this Company to assure that applicants are employed, and that employees are treated during employment, without regard to their race, religion, sex, color, national origin, age or disability. Such action shall include: employment, upgrading, demotion, or transfer; recruitment or recruitment advertising; layoff or termination; rates of pay or other forms of compensation; and selection for training, including apprenticeship, pre-apprenticeship, and/or on-the-job training."
2. **EEO Officer:** The contractor will designate and make known to the contracting officers an EEO Officer who will have the responsibility for and must be capable of effectively administering and promoting an active EEO program and who must be assigned adequate authority and responsibility to do so.
3. **Dissemination of Policy:** All members of the contractor's staff who are authorized to hire, supervise, promote, and discharge employees, or who recommend such action, or who are substantially involved in such action, will be made fully cognizant of, and will implement, the contractor's EEO policy and contractual responsibilities to provide EEO in each grade and classification of employment. To ensure that the above agreement will be met, the following actions will be taken as a minimum:
  - a. Periodic meetings of supervisory and personnel office employees will be conducted before the start of work and then not less often than once every six months, at which time the contractor's EEO policy and its implementation will be reviewed and explained. The meetings will be conducted by the EEO Officer.
  - b. All new supervisory or personnel office employees will be given a thorough indoctrination by the EEO Officer, covering all major aspects of the contractor's EEO obligations within thirty days following their reporting for duty with the contractor.
  - c. All personnel who are engaged in direct recruitment for the project will be instructed by the EEO Officer in the contractor's procedures for locating and hiring minorities and women.
  - d. Notices and posters setting forth the contractor's EEO policy will be placed in areas readily accessible to employees, applicants for employment and potential employees.
  - e. The contractor's EEO policy and the procedures to implement such policy will be brought to the attention of employees by means of meetings, employee handbooks, or other appropriate means.
4. **Recruitment:** When advertising for employees, the contractor will include in all advertisements for employees the notation: "An Equal Opportunity Employer." All such advertisements will be placed in publications having a large circulation among minorities and women in the area from which the project work force would normally be derived.
  - a. The contractor will, unless precluded by a valid bargaining agreement, conduct systematic and direct recruitment through public and private employee referral sources likely to yield qualified minorities and women. To meet this requirement, the contractor will identify sources of potential minority group employees, and establish with such identified sources procedures whereby minority and women applicants may be referred to the contractor for employment consideration.
  - b. In the event the contractor has a valid bargaining agreement providing for exclusive hiring hall referrals, the contractor is expected to observe the provisions of that agreement to the extent that the system meets the contractor's compliance with EEO contract provisions. Where implementation of such an agreement has the effect of discriminating against minorities or women, or obligates the contractor to do the same, such implementation violates Federal nondiscrimination provisions.
  - c. The contractor will encourage its present employees to refer minorities and women as applicants for employment. Information and procedures with regard to referring such applicants will be discussed with employees.
5. **Personnel Actions:** Wages, working conditions, and employee benefits shall be established and administered, and personnel actions of every type, including hiring, upgrading, promotion, transfer, demotion, layoff, and termination, shall be taken without regard to race, color, religion, sex, national origin, age or disability. The following procedures shall be followed:
  - a. The contractor will conduct periodic inspections of project sites to insure that working conditions and employee facilities do not indicate discriminatory treatment of project site personnel.
  - b. The contractor will periodically evaluate the spread of wages paid within each classification to determine any evidence of discriminatory wage practices.
  - c. The contractor will periodically review selected personnel actions in depth to determine whether there is evidence of discrimination. Where evidence is found, the contractor will promptly take corrective action. If the review indicates that the discrimination may extend beyond the actions reviewed, such corrective action shall include all affected persons.
  - d. The contractor will promptly investigate all complaints of alleged discrimination made to the contractor in connection with its obligations under this contract, will attempt to resolve such complaints, and will take appropriate corrective action within a reasonable time. If the investigation indicates that the discrimination may affect persons other than the complainant, such corrective action shall include such other persons. Upon completion of each investigation, the contractor will inform every complainant of all of their avenues of appeal.
6. **Training and Promotion:**
  - a. The contractor will assist in locating, qualifying, and increasing the skills of minorities and women who are applicants for employment or current employees. Such efforts should be aimed at developing full journey level status employees in the type of trade or job classification involved.
  - b. Consistent with the contractor's work force requirements and as permissible under Federal and State regulations, the contractor shall make full use of training programs, i.e., apprenticeship, and on-the-job training programs for the geographical area of contract performance. In the event a special provision for training is provided under this contract, this subparagraph will be superseded as indicated in the special provision. The contracting agency may reserve training positions for persons who receive welfare assistance in accordance with 23 U.S.C. 140(a).
  - c. The contractor will advise employees and applicants for employment of available training programs and entrance requirements for each.
  - d. The contractor will periodically review the training and promotion potential of employees who are minorities and women and will encourage eligible employees to apply for such training and promotion.

7. **Unions:** If the contractor relies in whole or in part upon unions as a source of employees, the contractor will use good faith efforts to obtain the cooperation of such unions to increase opportunities for minorities and women. Actions by the contractor, either directly or through a contractor's association acting as agent, will include the procedures set forth below:
  - a. The contractor will use good faith efforts to develop, in cooperation with the unions, joint training programs aimed toward qualifying more minorities and women for membership in the unions and increasing the skills of minorities and women so that they may qualify for higher paying employment.
  - b. The contractor will use good faith efforts to incorporate an EEO clause into each union agreement to the end that such union will be contractually bound to refer applicants without regard to their race, color, religion, sex, national origin, age or disability.
  - c. The contractor is to obtain information as to the referral practices and policies of the labor union except that to the extent such information is within the exclusive possession of the labor union and such labor union refuses to furnish such information to the contractor, the contractor shall so certify to the contracting agency and shall set forth what efforts have been made to obtain such information.
  - d. In the event the union is unable to provide the contractor with a reasonable flow of referrals within the time limit set forth in the collective bargaining agreement, the contractor will, through independent recruitment efforts, fill the employment vacancies without regard to race, color, religion, sex, national origin, age or disability; making full efforts to obtain qualified and/or qualifiable minorities and women. The failure of a union to provide sufficient referrals (even though it is obligated to provide exclusive referrals under the terms of a collective bargaining agreement) does not relieve the contractor from the requirements of this paragraph. In the event the union referral practice prevents the contractor from meeting the obligations pursuant to Executive Order 11246, as amended, and these special provisions, such contractor shall immediately notify the contracting agency.
8. **Reasonable Accommodation for Applicants / Employees with Disabilities:** The contractor must be familiar with the requirements for and comply with the Americans with Disabilities Act and all rules and regulations established there under. Employers must provide reasonable accommodation in all employment activities unless to do so would cause an undue hardship.
9. **Selection of Subcontractors, Procurement of Materials and Leasing of Equipment:** The contractor shall not discriminate on the grounds of race, color, religion, sex, national origin, age or disability in the selection and retention of subcontractors, including procurement of materials and leases of equipment. The contractor shall take all necessary and reasonable steps to ensure nondiscrimination in the administration of this contract.
  - a. The contractor shall notify all potential subcontractors and suppliers and lessors of their EEO obligations under this contract.
  - b. The contractor will use good faith efforts to ensure subcontractor compliance with their EEO obligations.
10. **Assurance Required by 49 CFR 26.13(b):**
  - a. The requirements of 49 CFR Part 26 and the State DOT's U.S. DOT-approved DBE program are incorporated by reference.
  - b. The contractor or subcontractor shall not discriminate on the basis of race, color, national origin, or sex in the performance of this contract. The contractor shall carry out applicable requirements of 49 CFR Part 26 in the award and administration of DOT-assisted contracts. Failure by the contractor to carry out these requirements is a material breach of this contract, which may result in the termination of this contract or such other remedy as the contracting agency deems appropriate.
11. **Records and Reports:** The contractor shall keep such records as necessary to document compliance with the EEO requirements. Such records shall be retained for a period of three years following the date of the final payment to the contractor for all contract work and shall be available at reasonable times and places for inspection by authorized representatives of the contracting agency and the FHWA.
  - a. The records kept by the contractor shall document the following:
    - (1) The number and work hours of minority and non-minority group members and women employed in each work classification on the project;
    - (2) The progress and efforts being made in cooperation with unions, when applicable, to increase employment opportunities for minorities and women; and
    - (3) The progress and efforts being made in locating, hiring, training, qualifying, and upgrading minorities and women;
  - b. The contractors and subcontractors will submit an annual report to the contracting agency each July for the duration of the project, indicating the number of minority, women, and non-minority group employees currently engaged in each work classification required by the contract work. This information is to be reported on Form FHWA-1391. The staffing data should represent the project work force on board in all or any part of the last payroll period preceding the end of July. If on-the-job training is being required by special provision, the contractor will be required to collect and report training data. The employment data should reflect the work force on board during all or any part of the last payroll period preceding the end of July.

### III. NONSEGREGATED FACILITIES

This provision is applicable to all Federal-aid construction contracts and to all related construction subcontracts of \$10,000 or more.

The contractor must ensure that facilities provided for employees are provided in such a manner that segregation on the basis of race, color, religion, sex, or national origin cannot result. The contractor may neither require such segregated use by written or oral policies nor tolerate such use by employee custom. The contractor's obligation extends further to ensure that its employees are not assigned to perform their services at any location, under the contractor's control, where the facilities are segregated. The term "facilities" includes waiting rooms, work areas, restaurants and other eating areas, time clocks, restrooms, washrooms, locker rooms, and other storage or dressing areas, parking lots, drinking fountains, recreation or entertainment areas, transportation, and housing provided for employees. The contractor shall provide separate or single-user restrooms and necessary dressing or sleeping areas to assure privacy between sexes.

### IV. DAVIS-BACON AND RELATED ACT PROVISIONS

This section is applicable to all Federal-aid construction projects exceeding \$2,000 and to all related subcontracts and lower-tier subcontracts (regardless of subcontract size). The requirements apply to all projects located within the right-of-way of a roadway that is functionally classified as Federal-aid highway. This excludes roadways functionally classified as local roads or rural minor collectors, which are exempt. Contracting agencies may elect to apply these requirements to other projects.

The following provisions are from the U.S. Department of Labor regulations in 29 CFR 5.5 "Contract provisions and related matters" with minor revisions to conform to the FHWA-1273 format and FHWA program requirements.

#### 1. Minimum wages

- a. All laborers and mechanics employed or working upon the site of the work, will be paid unconditionally and not less often than once a week, and without subsequent deduction or rebate on any account (except such payroll deductions as are permitted by regulations issued by the Secretary of Labor under the Copeland Act (29 CFR part 3)), the full amount of wages and bona fide fringe benefits (or cash equivalents

thereof) due at time of payment computed at rates not less than those contained in the wage determination of the Secretary of Labor which is attached hereto and made a part hereof, regardless of any contractual relationship which may be alleged to exist between the contractor and such laborers and mechanics.

Contributions made or costs reasonably anticipated for bona fide fringe benefits under section 1(b)(2) of the Davis-Bacon Act on behalf of laborers or mechanics are considered wages paid to such laborers or mechanics, subject to the provisions of paragraph 1.d. of this section; also, regular contributions made or costs incurred for more than a weekly period (but not less often than quarterly) under plans, funds, or programs which cover the particular weekly period, are deemed to be constructively made or incurred during such weekly period. Such laborers and mechanics shall be paid the appropriate wage rate and fringe benefits on the wage determination for the classification of work actually performed, without regard to skill, except as provided in 29 CFR 5.5(a)(4). Laborers or mechanics performing work in more than one classification may be compensated at the rate specified for each classification for the time actually worked therein: Provided, That the employer's payroll records accurately set forth the time spent in each classification in which work is performed. The wage determination (including any additional classification and wage rates conformed under paragraph 1.b. of this section) and the Davis-Bacon poster (WH-1321) shall be posted at all times by the contractor and its subcontractors at the site of the work in a prominent and accessible place where it can be easily seen by the workers.

- b. (1) The contracting officer shall require that any class of laborers or mechanics, including helpers, which is not listed in the wage determination and which is to be employed under the contract shall be classified in conformance with the wage determination. The contracting officer shall approve an additional classification and wage rate and fringe benefits therefore only when the following criteria have been met:
    - (i) The work to be performed by the classification requested is not performed by a classification in the wage determination; and
    - (ii) The classification is utilized in the area by the construction industry; and
    - (iii) The proposed wage rate, including any bona fide fringe benefits, bears a reasonable relationship to the wage rates contained in the wage determination.
  - (2) If the contractor and the laborers and mechanics to be employed in the classification (if known), or their representatives, and the contracting officer agree on the classification and wage rate (including the amount designated for fringe benefits where appropriate), a report of the action taken shall be sent by the contracting officer to the Administrator of the Wage and Hour Division, Employment Standards Administration, U.S. Department of Labor, Washington, DC 20210. The Administrator, or an authorized representative, will approve, modify, or disapprove every additional classification action within 30 days of receipt and so advise the contracting officer or will notify the contracting officer within the 30-day period that additional time is necessary.
  - (3) In the event the contractor, the laborers or mechanics to be employed in the classification or their representatives, and the contracting officer do not agree on the proposed classification and wage rate (including the amount designated for fringe benefits, where appropriate), the contracting officer shall refer the questions, including the views of all interested parties and the recommendation of the contracting officer, to the Wage and Hour Administrator for determination. The Wage and Hour Administrator, or an authorized representative, will issue a determination within 30 days of receipt and so advise the contracting officer or will notify the contracting officer within the 30-day period that additional time is necessary.
  - (4) The wage rate (including fringe benefits where appropriate) determined pursuant to paragraphs 1.b.(2) or 1.b.(3) of this section, shall be paid to all workers performing work in the classification under this contract from the first day on which work is performed in the classification.
- c. Whenever the minimum wage rate prescribed in the contract for a class of laborers or mechanics includes a fringe benefit which is not expressed as an hourly rate, the contractor shall either pay the benefit as stated in the wage determination or shall pay another bona fide fringe benefit or an hourly cash equivalent thereof.
  - d. If the contractor does not make payments to a trustee or other third person, the contractor may consider as part of the wages of any laborer or mechanic the amount of any costs reasonably anticipated in providing bona fide fringe benefits under a plan or program, Provided, That the Secretary of Labor has found, upon the written request of the contractor, that the applicable standards of the Davis-Bacon Act have been met. The Secretary of Labor may require the contractor to set aside in a separate account assets for the meeting of obligations under the plan or program.
2. **Withholding.** The contracting agency shall upon its own action or upon written request of an authorized representative of the Department of Labor, withhold or cause to be withheld from the contractor under this contract, or any other Federal contract with the same prime contractor, or any other federally-assisted contract subject to Davis-Bacon prevailing wage requirements, which is held by the same prime contractor, so much of the accrued payments or advances as may be considered necessary to pay laborers and mechanics, including apprentices, trainees, and helpers, employed by the contractor or any subcontractor the full amount of wages required by the contract. In the event of failure to pay any laborer or mechanic, including any apprentice, trainee, or helper, employed or working on the site of the work, all or part of the wages required by the contract, the contracting agency may, after written notice to the contractor, take such action as may be necessary to cause the suspension of any further payment, advance, or guarantee of funds until such violations have ceased.
  3. **Payrolls and basic records**
    - a. Payrolls and basic records relating thereto shall be maintained by the contractor during the course of the work and preserved for a period of three years thereafter for all laborers and mechanics working at the site of the work. Such records shall contain the name, address, and social security number of each such worker, his or her correct classification, hourly rates of wages paid (including rates of contributions or costs anticipated for bona fide fringe benefits or cash equivalents thereof of the types described in section 1(b)(2)(B) of the Davis-Bacon Act), daily and weekly number of hours worked, deductions made and actual wages paid. Whenever the Secretary of Labor has found under 29 CFR 5.5(a)(1)(iv) that the wages of any laborer or mechanic include the amount of any costs reasonably anticipated in providing benefits under a plan or program described in section 1(b)(2)(B) of the Davis-Bacon Act, the contractor shall maintain records which show that the commitment to provide such benefits is enforceable, that the plan or program is financially responsible, and that the plan or program has been communicated in writing to the laborers or mechanics affected, and records which show the costs anticipated or the actual cost incurred in providing such benefits. Contractors employing apprentices or trainees under approved programs shall maintain written evidence of the registration of apprenticeship programs and certification of trainee programs, the registration of the apprentices and trainees, and the ratios and wage rates prescribed in the applicable programs.
    - b. (1) The contractor shall submit weekly for each week in which any contract work is performed a copy of all payrolls to the contracting agency. The payrolls submitted shall set out accurately and completely all of the information required to be maintained under 29 CFR 5.5(a)(3)(i), except that full social security numbers and home addresses shall not be included on weekly transmittals. Instead the payrolls shall only need to include an individually identifying number for each employee ( e.g. , the last four digits of the employee's social security number). The required weekly payroll information may be submitted in any form desired. Optional Form WH-347 is available for

this purpose from the Wage and Hour Division Web site at <http://www.dol.gov/esa/whd/forms/wh347instr.htm> or its successor site. The prime contractor is responsible for the submission of copies of payrolls by all subcontractors. Contractors and subcontractors shall maintain the full social security number and current address of each covered worker, and shall provide them upon request to the contracting agency for transmission to the State DOT, the FHWA or the Wage and Hour Division of the Department of Labor for purposes of an investigation or audit of compliance with prevailing wage requirements. It is not a violation of this section for a prime contractor to require a subcontractor to provide addresses and social security numbers to the prime contractor for its own records, without weekly submission to the contracting agency.

- (2) Each payroll submitted shall be accompanied by a "Statement of Compliance," signed by the contractor or subcontractor or his or her agent who pays or supervises the payment of the persons employed under the contract and shall certify the following:
    - (i) That the payroll for the payroll period contains the information required to be provided under §5.5 (a)(3)(ii) of Regulations, 29 CFR part 5, the appropriate information is being maintained under §5.5 (a)(3)(i) of Regulations, 29 CFR part 5, and that such information is correct and complete;
    - (ii) That each laborer or mechanic (including each helper, apprentice, and trainee) employed on the contract during the payroll period has been paid the full weekly wages earned, without rebate, either directly or indirectly, and that no deductions have been made either directly or indirectly from the full wages earned, other than permissible deductions as set forth in Regulations, 29 CFR part 3;
    - (iii) That each laborer or mechanic has been paid not less than the applicable wage rates and fringe benefits or cash equivalents for the classification of work performed, as specified in the applicable wage determination incorporated into the contract.
  - (3) The weekly submission of a properly executed certification set forth on the reverse side of Optional Form WH-347 shall satisfy the requirement for submission of the "Statement of Compliance" required by paragraph 3.b.(2) of this section.
  - (4) The falsification of any of the above certifications may subject the contractor or subcontractor to civil or criminal prosecution under section 1001 of title 18 and section 231 of title 31 of the United States Code.
- c. The contractor or subcontractor shall make the records required under paragraph 3.a. of this section available for inspection, copying, or transcription by authorized representatives of the contracting agency, the State DOT, the FHWA, or the Department of Labor, and shall permit such representatives to interview employees during working hours on the job. If the contractor or subcontractor fails to submit the required records or to make them available, the FHWA may, after written notice to the contractor, the contracting agency or the State DOT, take such action as may be necessary to cause the suspension of any further payment, advance, or guarantee of funds. Furthermore, failure to submit the required records upon request or to make such records available may be grounds for debarment action pursuant to 29 CFR 5.12.
4. **Apprentices and trainees**
- a. Apprentices (programs of the USDOL). Apprentices will be permitted to work at less than the predetermined rate for the work they performed when they are employed pursuant to and individually registered in a bona fide apprenticeship program registered with the U.S. Department of Labor, Employment and Training Administration, Office of Apprenticeship Training, Employer and Labor Services, or with a State Apprenticeship Agency recognized by the Office, or if a person is employed in his or her first 90 days of probationary employment as an apprentice in such an apprenticeship program, who is not individually registered in the program, but who has been certified by the Office of Apprenticeship Training, Employer and Labor Services or a State Apprenticeship Agency (where appropriate) to be eligible for probationary employment as an apprentice.
 

The allowable ratio of apprentices to journeymen on the job site in any craft classification shall not be greater than the ratio permitted to the contractor as to the entire work force under the registered program. Any worker listed on a payroll at an apprentice wage rate, who is not registered or otherwise employed as stated above, shall be paid not less than the applicable wage rate on the wage determination for the classification of work actually performed. In addition, any apprentice performing work on the job site in excess of the ratio permitted under the registered program shall be paid not less than the applicable wage rate on the wage determination for the work actually performed. Where a contractor is performing construction on a project in a locality other than that in which its program is registered, the ratios and wage rates (expressed in percentages of the journeyman's hourly rate) specified in the contractor's or subcontractor's registered program shall be observed.

Every apprentice must be paid at not less than the rate specified in the registered program for the apprentice's level of progress, expressed as a percentage of the journeymen hourly rate specified in the applicable wage determination. Apprentices shall be paid fringe benefits in accordance with the provisions of the apprenticeship program. If the apprenticeship program does not specify fringe benefits, apprentices must be paid the full amount of fringe benefits listed on the wage determination for the applicable classification. If the Administrator determines that a different practice prevails for the applicable apprentice classification, fringes shall be paid in accordance with that determination.

In the event the Office of Apprenticeship Training, Employer and Labor Services, or a State Apprenticeship Agency recognized by the Office, withdraws approval of an apprenticeship program, the contractor will no longer be permitted to utilize apprentices at less than the applicable predetermined rate for the work performed until an acceptable program is approved.
  - b. Trainees (programs of the USDOL). Except as provided in 29 CFR 5.16, trainees will not be permitted to work at less than the predetermined rate for the work performed unless they are employed pursuant to and individually registered in a program which has received prior approval, evidenced by formal certification by the U.S. Department of Labor, Employment and Training Administration.
 

The ratio of trainees to journeymen on the job site shall not be greater than permitted under the plan approved by the Employment and Training Administration.

Every trainee must be paid at not less than the rate specified in the approved program for the trainee's level of progress, expressed as a percentage of the journeyman hourly rate specified in the applicable wage determination. Trainees shall be paid fringe benefits in accordance with the provisions of the trainee program. If the trainee program does not mention fringe benefits, trainees shall be paid the full amount of fringe benefits listed on the wage determination unless the Administrator of the Wage and Hour Division determines that there is an apprenticeship program associated with the corresponding journeyman wage rate on the wage determination which provides for less than full fringe benefits for apprentices. Any employee listed on the payroll at a trainee rate who is not registered and participating in a training plan approved by the Employment and Training Administration shall be paid not less than the applicable wage rate on the wage determination for the classification of work actually performed. In addition, any trainee performing work on the job site in excess of the ratio permitted under the registered program shall be paid not less than the applicable wage rate on the wage determination for the work actually performed.

In the event the Employment and Training Administration withdraws approval of a training program, the contractor will no longer be permitted to utilize trainees at less than the applicable predetermined rate for the work performed until an acceptable program is approved.
  - c. Equal employment opportunity. The utilization of apprentices, trainees and journeymen under this part shall be in conformity with the equal employment opportunity requirements of Executive Order 11246, as amended, and 29 CFR part 30.
  - d. Apprentices and Trainees (programs of the U.S. DOT). Apprentices and trainees working under apprenticeship and skill training programs which have been certified by the Secretary of Transportation as promoting EEO in connection with Federal-aid highway construction programs

are not subject to the requirements of paragraph 4 of this Section IV. The straight time hourly wage rates for apprentices and trainees under such programs will be established by the particular programs. The ratio of apprentices and trainees to journeymen shall not be greater than permitted by the terms of the particular program.

5. **Compliance with Copeland Act requirements.** The contractor shall comply with the requirements of 29 CFR part 3, which are incorporated by reference in this contract.
6. **Subcontracts.** The contractor or subcontractor shall insert Form FHWA-1273 in any subcontracts and also require the subcontractors to include Form FHWA-1273 in any lower tier subcontracts. The prime contractor shall be responsible for the compliance by any subcontractor or lower tier subcontractor with all the contract clauses in 29 CFR 5.5.
7. **Contract termination:** debarment. A breach of the contract clauses in 29 CFR 5.5 may be grounds for termination of the contract, and for debarment as a contractor and a subcontractor as provided in 29 CFR 5.12.
8. **Compliance with Davis-Bacon and Related Act requirements.** All rulings and interpretations of the Davis-Bacon and Related Acts contained in 29 CFR parts 1, 3, and 5 are herein incorporated by reference in this contract.
9. **Disputes concerning labor standards.** Disputes arising out of the labor standards provisions of this contract shall not be subject to the general disputes clause of this contract. Such disputes shall be resolved in accordance with the procedures of the Department of Labor set forth in 29 CFR parts 5, 6, and 7. Disputes within the meaning of this clause include disputes between the contractor (or any of its subcontractors) and the contracting agency, the U.S. Department of Labor, or the employees or their representatives.
10. **Certification of eligibility.**
  - a. By entering into this contract, the contractor certifies that neither it (nor he or she) nor any person or firm who has an interest in the contractor's firm is a person or firm ineligible to be awarded Government contracts by virtue of section 3(a) of the Davis-Bacon Act or 29 CFR 5.12(a)(1).
  - b. No part of this contract shall be subcontracted to any person or firm ineligible for award of a Government contract by virtue of section 3(a) of the Davis-Bacon Act or 29 CFR 5.12(a)(1).
  - c. The penalty for making false statements is prescribed in the U.S. Criminal Code, 18 U.S.C. 1001.

#### V. CONTRACT WORK HOURS AND SAFETY STANDARDS ACT

The following clauses apply to any Federal-aid construction contract in an amount in excess of \$100,000 and subject to the overtime provisions of the Contract Work Hours and Safety Standards Act. These clauses shall be inserted in addition to the clauses required by 29 CFR 5.5(a) or 29 CFR 4.6. As used in this paragraph, the terms laborers and mechanics include watchmen and guards.

1. **Overtime requirements.** No contractor or subcontractor contracting for any part of the contract work which may require or involve the employment of laborers or mechanics shall require or permit any such laborer or mechanic in any workweek in which he or she is employed on such work to work in excess of forty hours in such workweek unless such laborer or mechanic receives compensation at a rate not less than one and one-half times the basic rate of pay for all hours worked in excess of forty hours in such workweek.
2. **Violation; liability for unpaid wages; liquidated damages.** In the event of any violation of the clause set forth in paragraph (1.) of this section, the contractor and any subcontractor responsible therefor shall be liable for the unpaid wages. In addition, such contractor and subcontractor shall be liable to the United States (in the case of work done under contract for the District of Columbia or a territory, to such District or to such territory), for liquidated damages. Such liquidated damages shall be computed with respect to each individual laborer or mechanic, including watchmen and guards, employed in violation of the clause set forth in paragraph (1.) of this section, in the sum of \$10 for each calendar day on which such individual was required or permitted to work in excess of the standard workweek of forty hours without payment of the overtime wages required by the clause set forth in paragraph (1.) of this section.
3. **Withholding for unpaid wages and liquidated damages.** The FHWA or the contracting agency shall upon its own action or upon written request of an authorized representative of the Department of Labor withhold or cause to be withheld, from any moneys payable on account of work performed by the contractor or subcontractor under any such contract or any other Federal contract with the same prime contractor, or any other federally-assisted contract subject to the Contract Work Hours and Safety Standards Act, which is held by the same prime contractor, such sums as may be determined to be necessary to satisfy any liabilities of such contractor or subcontractor for unpaid wages and liquidated damages as provided in the clause set forth in paragraph (2.) of this section.
4. **Subcontracts.** The contractor or subcontractor shall insert in any subcontracts the clauses set forth in paragraph (1.) through (4.) of this section and also a clause requiring the subcontractors to include these clauses in any lower tier subcontracts. The prime contractor shall be responsible for compliance by any subcontractor or lower tier subcontractor with the clauses set forth in paragraphs (1.) through (4.) of this section.

#### VI. SUBLETTING OR ASSIGNING THE CONTRACT

This provision is applicable to all Federal-aid construction contracts on the National Highway System.

1. The contractor shall perform with its own organization contract work amounting to not less than 30 percent (or a greater percentage if specified elsewhere in the contract) of the total original contract price, excluding any specialty items designated by the contracting agency. Specialty items may be performed by subcontract and the amount of any such specialty items performed may be deducted from the total original contract price before computing the amount of work required to be performed by the contractor's own organization (23 CFR 635.116).
  - a. The term "perform work with its own organization" refers to workers employed or leased by the prime contractor, and equipment owned or rented by the prime contractor, with or without operators. Such term does not include employees or equipment of a subcontractor or lower tier subcontractor, agents of the prime contractor, or any other assignees. The term may include payments for the costs of hiring leased employees

from an employee leasing firm meeting all relevant Federal and State regulatory requirements. Leased employees may only be included in this term if the prime contractor meets all of the following conditions:

- (1) the prime contractor maintains control over the supervision of the day-to-day activities of the leased employees;
  - (2) the prime contractor remains responsible for the quality of the work of the leased employees;
  - (3) the prime contractor retains all power to accept or exclude individual employees from work on the project; and
  - (4) the prime contractor remains ultimately responsible for the payment of predetermined minimum wages, the submission of payrolls, statements of compliance and all other Federal regulatory requirements.
- b. "Specialty Items" shall be construed to be limited to work that requires highly specialized knowledge, abilities, or equipment not ordinarily available in the type of contracting organizations qualified and expected to bid or propose on the contract as a whole and in general are to be limited to minor components of the overall contract.
2. The contract amount upon which the requirements set forth in paragraph (1) of Section VI is computed includes the cost of material and manufactured products which are to be purchased or produced by the contractor under the contract provisions.
  3. The contractor shall furnish (a) a competent superintendent or supervisor who is employed by the firm, has full authority to direct performance of the work in accordance with the contract requirements, and is in charge of all construction operations (regardless of who performs the work) and (b) such other of its own organizational resources (supervision, management, and engineering services) as the contracting officer determines is necessary to assure the performance of the contract.
  4. No portion of the contract shall be sublet, assigned or otherwise disposed of except with the written consent of the contracting officer, or authorized representative, and such consent when given shall not be construed to relieve the contractor of any responsibility for the fulfillment of the contract. Written consent will be given only after the contracting agency has assured that each subcontract is evidenced in writing and that it contains all pertinent provisions and requirements of the prime contract.
  5. The 30% self-performance requirement of paragraph (1) is not applicable to design-build contracts; however, contracting agencies may establish their own self-performance requirements.

#### **VII. SAFETY: ACCIDENT PREVENTION**

This provision is applicable to all Federal-aid construction contracts and to all related subcontracts.

1. In the performance of this contract the contractor shall comply with all applicable Federal, State, and local laws governing safety, health, and sanitation (23 CFR 635). The contractor shall provide all safeguards, safety devices and protective equipment and take any other needed actions as it determines, or as the contracting officer may determine, to be reasonably necessary to protect the life and health of employees on the job and the safety of the public and to protect property in connection with the performance of the work covered by the contract.
2. It is a condition of this contract, and shall be made a condition of each subcontract, which the contractor enters into pursuant to this contract, that the contractor and any subcontractor shall not permit any employee, in performance of the contract, to work in surroundings or under conditions which are unsanitary, hazardous or dangerous to his/her health or safety, as determined under construction safety and health standards (29 CFR 1926) promulgated by the Secretary of Labor, in accordance with Section 107 of the Contract Work Hours and Safety Standards Act (40 U.S.C. 3704).
3. Pursuant to 29 CFR 1926.3, it is a condition of this contract that the Secretary of Labor or authorized representative thereof, shall have right of entry to any site of contract performance to inspect or investigate the matter of compliance with the construction safety and health standards and to carry out the duties of the Secretary under Section 107 of the Contract Work Hours and Safety Standards Act (40 U.S.C.3704).

#### **VIII. FALSE STATEMENTS CONCERNING HIGHWAY PROJECTS**

This provision is applicable to all Federal-aid construction contracts and to all related subcontracts.

In order to assure high quality and durable construction in conformity with approved plans and specifications and a high degree of reliability on statements and representations made by engineers, contractors, suppliers, and workers on Federal-aid highway projects, it is essential that all persons concerned with the project perform their functions as carefully, thoroughly, and honestly as possible. Willful falsification, distortion, or misrepresentation with respect to any facts related to the project is a violation of Federal law. To prevent any misunderstanding regarding the seriousness of these and similar acts, Form FHWA-1022 shall be posted on each Federal-aid highway project (23 CFR 635) in one or more places where it is readily available to all persons concerned with the project:

18 U.S.C. 1020 reads as follows:

"Whoever, being an officer, agent, or employee of the United States, or of any State or Territory, or whoever, whether a person, association, firm, or corporation, knowingly makes any false statement, false representation, or false report as to the character, quality, quantity, or cost of the material used or to be used, or the quantity or quality of the work performed or to be performed, or the cost thereof in connection with the submission of plans, maps, specifications, contracts, or costs of construction on any highway or related project submitted for approval to the Secretary of Transportation; or

Whoever knowingly makes any false statement, false representation, false report or false claim with respect to the character, quality, quantity, or cost of any work performed or to be performed, or materials furnished or to be furnished, in connection with the construction of any highway or related project approved by the Secretary of Transportation; or

Whoever knowingly makes any false statement or false representation as to material fact in any statement, certificate, or report submitted pursuant to provisions of the Federal-aid Roads Act approved July 1, 1916, (39 Stat. 355), as amended and supplemented;

Shall be fined under this title or imprisoned not more than 5 years or both."

#### **IX. IMPLEMENTATION OF CLEAN AIR ACT AND FEDERAL WATER POLLUTION CONTROL ACT**

This provision is applicable to all Federal-aid construction contracts and to all related subcontracts.

By submission of this bid/proposal or the execution of this contract, or subcontract, as appropriate, the bidder, proposer, Federal-aid construction contractor, or subcontractor, as appropriate, will be deemed to have stipulated as follows:

1. That any person who is or will be utilized in the performance of this contract is not prohibited from receiving an award due to a violation of Section 508 of the Clean Water Act or Section 306 of the Clean Air Act.
2. That the contractor agrees to include or cause to be included the requirements of paragraph (1) of this Section X in every subcontract, and further agrees to take such action as the contracting agency may direct as a means of enforcing such requirements.



**X. CERTIFICATION REGARDING DEBARMENT, SUSPENSION, INELIGIBILITY AND VOLUNTARY EXCLUSION**

This provision is applicable to all Federal-aid construction contracts, design-build contracts, subcontracts, lower-tier subcontracts, purchase orders, lease agreements, consultant contracts or any other covered transaction requiring FHWA approval or that is estimated to cost \$25,000 or more – as defined in 2 CFR Parts 180 and 1200.

**1. Instructions for Certification – First Tier Participants:**

- a. By signing and submitting this proposal, the prospective first tier participant is providing the certification set out below.
- b. The inability of a person to provide the certification set out below will not necessarily result in denial of participation in this covered transaction. The prospective first tier participant shall submit an explanation of why it cannot provide the certification set out below. The certification or explanation will be considered in connection with the department or agency's determination whether to enter into this transaction. However, failure of the prospective first tier participant to furnish a certification or an explanation shall disqualify such a person from participation in this transaction.
- c. The certification in this clause is a material representation of fact upon which reliance was placed when the contracting agency determined to enter into this transaction. If it is later determined that the prospective participant knowingly rendered an erroneous certification, in addition to other remedies available to the Federal Government, the contracting agency may terminate this transaction for cause of default.
- d. The prospective first tier participant shall provide immediate written notice to the contracting agency to whom this proposal is submitted if any time the prospective first tier participant learns that its certification was erroneous when submitted or has become erroneous by reason of changed circumstances.
- e. The terms "covered transaction," "debarred," "suspended," "ineligible," "participant," "person," "principal," and "voluntarily excluded," as used in this clause, are defined in 2 CFR Parts 180 and 1200. "First Tier Covered Transactions" refers to any covered transaction between a grantee or subgrantee of Federal funds and a participant (such as the prime or general contract). "Lower Tier Covered Transactions" refers to any covered transaction under a First Tier Covered Transaction (such as subcontracts). "First Tier Participant" refers to the participant who has entered into a covered transaction with a grantee or subgrantee of Federal funds (such as the prime or general contractor). "Lower Tier Participant" refers any participant who has entered into a covered transaction with a First Tier Participant or other Lower Tier Participants (such as subcontractors and suppliers).
- f. The prospective first tier participant agrees by submitting this proposal that, should the proposed covered transaction be entered into, it shall not knowingly enter into any lower tier covered transaction with a person who is debarred, suspended, declared ineligible, or voluntarily excluded from participation in this covered transaction, unless authorized by the department or agency entering into this transaction.
- g. The prospective first tier participant further agrees by submitting this proposal that it will include the clause titled "Certification Regarding Debarment, Suspension, Ineligibility and Voluntary Exclusion-Lower Tier Covered Transactions," provided by the department or contracting agency, entering into this covered transaction, without modification, in all lower tier covered transactions and in all solicitations for lower tier covered transactions exceeding the \$25,000 threshold.
- h. A participant in a covered transaction may rely upon a certification of a prospective participant in a lower tier covered transaction that is not debarred, suspended, ineligible, or voluntarily excluded from the covered transaction, unless it knows that the certification is erroneous. A participant is responsible for ensuring that its principals are not suspended, debarred, or otherwise ineligible to participate in covered transactions. To verify the eligibility of its principals, as well as the eligibility of any lower tier prospective participants, each participant may, but is not required to, check the Excluded Parties List System website (<https://www.epls.gov/>), which is compiled by the General Services Administration.
- i. Nothing contained in the foregoing shall be construed to require the establishment of a system of records in order to render in good faith the certification required by this clause. The knowledge and information of the prospective participant is not required to exceed that which is normally possessed by a prudent person in the ordinary course of business dealings.
- j. Except for transactions authorized under paragraph (f) of these instructions, if a participant in a covered transaction knowingly enters into a lower tier covered transaction with a person who is suspended, debarred, ineligible, or voluntarily excluded from participation in this transaction, in addition to other remedies available to the Federal Government, the department or agency may terminate this transaction for cause or default.

\* \* \* \* \*

**2. Certification Regarding Debarment, Suspension, Ineligibility and Voluntary Exclusion – First Tier Participants:**

- a. The prospective first tier participant certifies to the best of its knowledge and belief, that it and its principals:
  - (1) Are not presently debarred, suspended, proposed for debarment, declared ineligible, or voluntarily excluded from participating in covered transactions by any Federal department or agency;
  - (2) Have not within a three-year period preceding this proposal been convicted of or had a civil judgment rendered against them for commission of fraud or a criminal offense in connection with obtaining, attempting to obtain, or performing a public (Federal, State or local) transaction or contract under a public transaction; violation of Federal or State antitrust statutes or commission of embezzlement, theft, forgery, bribery, falsification or destruction of records, making false statements, or receiving stolen property;
  - (3) Are not presently indicted for or otherwise criminally or civilly charged by a governmental entity (Federal, State or local) with commission of any of the offenses enumerated in paragraph (a)(2) of this certification; and
  - (4) Have not within a three-year period preceding this application/proposal had one or more public transactions (Federal, State or local) terminated for cause or default.
- b. Where the prospective participant is unable to certify to any of the statements in this certification, such prospective participant shall attach an explanation to this proposal.

**2. Instructions for Certification - Lower Tier Participants:**

(Applicable to all subcontracts, purchase orders and other lower tier transactions requiring prior FHWA approval or estimated to cost \$25,000 or more - 2 CFR Parts 180 and 1200)

- a. By signing and submitting this proposal, the prospective lower tier is providing the certification set out below.
- b. The certification in this clause is a material representation of fact upon which reliance was placed when this transaction was entered into. If it is later determined that the prospective lower tier participant knowingly rendered an erroneous certification, in addition to other remedies

- available to the Federal Government, the department, or agency with which this transaction originated may pursue available remedies, including suspension and/or debarment.
- c. The prospective lower tier participant shall provide immediate written notice to the person to which this proposal is submitted if at any time the prospective lower tier participant learns that its certification was erroneous by reason of changed circumstances.
  - d. The terms "covered transaction," "debarred," "suspended," "ineligible," "participant," "person," "principal," and "voluntarily excluded," as used in this clause, are defined in 2 CFR Parts 180 and 1200. You may contact the person to which this proposal is submitted for assistance in obtaining a copy of those regulations. "First Tier Covered Transactions" refers to any covered transaction between a grantee or subgrantee of Federal funds and a participant (such as the prime or general contractor). "Lower Tier Covered Transactions" refers to any covered transaction under a First Tier Covered Transaction (such as subcontracts). "First Tier Participant" refers to the participant who has entered into a covered transaction with a grantee or subgrantee of Federal funds (such as the prime or general contractor). "Lower Tier Participant" refers any participant who has entered into a covered transaction with a First Tier Participant or other Lower Tier Participants (such as subcontractors and suppliers).
  - e. The prospective lower tier participant agrees by submitting this proposal that, should the proposed covered transaction be entered into, it shall not knowingly enter into any lower tier covered transaction with a person who is debarred, suspended, declared ineligible, or voluntarily excluded from participation in this covered transaction, unless authorized by the department or agency with which this transaction originated.
  - f. The prospective lower tier participant further agrees by submitting this proposal that it will include this clause titled "Certification Regarding Debarment, Suspension, Ineligibility and Voluntary Exclusion-Lower Tier Covered Transaction," without modification, in all lower tier covered transactions and in all solicitations for lower tier covered transactions exceeding the \$25,000 threshold.
  - g. A participant in a covered transaction may rely upon a certification of a prospective participant in a lower tier covered transaction that is not debarred, suspended, ineligible, or voluntarily excluded from the covered transaction, unless it knows that the certification is erroneous. A participant is responsible for ensuring that its principals are not suspended, debarred, or otherwise ineligible to participate in covered transactions. To verify the eligibility of its principals, as well as the eligibility of any lower tier prospective participants, each participant may, but is not required to, check the Excluded Parties List System website (<https://www.epls.gov/>), which is compiled by the General Services Administration.
  - h. Nothing contained in the foregoing shall be construed to require establishment of a system of records in order to render in good faith the certification required by this clause. The knowledge and information of participant is not required to exceed that which is normally possessed by a prudent person in the ordinary course of business dealings.
  - i. Except for transactions authorized under paragraph e of these instructions, if a participant in a covered transaction knowingly enters into a lower tier covered transaction with a person who is suspended, debarred, ineligible, or voluntarily excluded from participation in this transaction, in addition to other remedies available to the Federal Government, the department or agency with which this transaction originated may pursue available remedies, including suspension and/or debarment.

\* \* \* \* \*

**Certification Regarding Debarment, Suspension, Ineligibility and Voluntary Exclusion--Lower Tier Participants:**

1. The prospective lower tier participant certifies, by submission of this proposal, that neither it nor its principals is presently debarred, suspended, proposed for debarment, declared ineligible, or voluntarily excluded from participating in covered transactions by any Federal department or agency.
2. Where the prospective lower tier participant is unable to certify to any of the statements in this certification, such prospective participant shall attach an explanation to this proposal.

\* \* \* \* \*

**XI. CERTIFICATION REGARDING USE OF CONTRACT FUNDS FOR LOBBYING**

This provision is applicable to all Federal-aid construction contracts and to all related subcontracts which exceed \$100,000 (49 CFR 20).

1. The prospective participant certifies, by signing and submitting this bid or proposal, to the best of his or her knowledge and belief, that:
  - a. No Federal appropriated funds have been paid or will be paid, by or on behalf of the undersigned, to any person for influencing or attempting to influence an officer or employee of any Federal agency, a Member of Congress, an officer or employee of Congress, or an employee of a Member of Congress in connection with the awarding of any Federal contract, the making of any Federal grant, the making of any Federal loan, the entering into of any cooperative agreement, and the extension, continuation, renewal, amendment, or modification of any Federal contract, grant, loan, or cooperative agreement.
  - b. If any funds other than Federal appropriated funds have been paid or will be paid to any person for influencing or attempting to influence an officer or employee of any Federal agency, a Member of Congress, an officer or employee of Congress, or an employee of a Member of Congress in connection with this Federal contract, grant, loan, or cooperative agreement, the undersigned shall complete and submit Standard Form-LLL, "Disclosure Form to Report Lobbying," in accordance with its instructions.
2. This certification is a material representation of fact upon which reliance was placed when this transaction was made or entered into. Submission of this certification is a prerequisite for making or entering into this transaction imposed by 31 U.S.C. 1352. Any person who fails to file the required certification shall be subject to a civil penalty of not less than \$10,000 and not more than \$100,000 for each such failure.
3. The prospective participant also agrees by submitting its bid or proposal that the participant shall require that the language of this certification be included in all lower tier subcontracts, which exceed \$100,000 and that all such recipients shall certify and disclose accordingly.

**STANDARD SPECIAL PROVISION****ON-THE-JOB TRAINING**

(10-16-07) (Rev. 4-21-15)

Z-10

**Description**

The North Carolina Department of Transportation will administer a custom version of the Federal On-the-Job Training (OJT) Program, commonly referred to as the Alternate OJT Program. All contractors (existing and newcomers) will be automatically placed in the Alternate Program. Standard OJT requirements typically associated with individual projects will no longer be applied at the project level. Instead, these requirements will be applicable on an annual basis for each contractor administered by the OJT Program Manager.

On the Job Training shall meet the requirements of 23 CFR 230.107 (b), 23 USC – Section 140, this provision and the On-the-Job Training Program Manual.

The Alternate OJT Program will allow a contractor to train employees on Federal, State and privately funded projects located in North Carolina. However, priority shall be given to training employees on NCDOT Federal-Aid funded projects.

**Minorities and Women**

Developing, training and upgrading of minorities and women toward journeyman level status is a primary objective of this special training provision. Accordingly, the Contractor shall make every effort to enroll minority and women as trainees to the extent that such persons are available within a reasonable area of recruitment. This training commitment is not intended, and shall not be used, to discriminate against any applicant for training, whether a member of a minority group or not.

**Assigning Training Goals**

The Department, through the OJT Program Manager, will assign training goals for a calendar year based on the contractors' past three years' activity and the contractors' anticipated upcoming year's activity with the Department. At the beginning of each year, all contractors eligible will be contacted by the Department to determine the number of trainees that will be assigned for the upcoming calendar year. At that time the Contractor shall enter into an agreement with the Department to provide a self-imposed on-the-job training program for the calendar year. This agreement will include a specific number of annual training goals agreed to by both parties. The number of training assignments may range from 1 to 15 per contractor per calendar year. The Contractor shall sign an agreement to fulfill their annual goal for the year.\

**Training Classifications**

The Contractor shall provide on-the-job training aimed at developing full journeyman level workers in the construction craft/operator positions. Preference shall be given to providing training in the following skilled work classifications:

Equipment Operators  
Truck Drivers  
Carpenters  
Concrete Finishers  
Pipe Layers

Office Engineers  
Estimators  
Iron / Reinforcing Steel Workers  
Mechanics  
Welders

The Department has established common training classifications and their respective training requirements that may be used by the contractors. However, the classifications established are not all-inclusive. Where the training is oriented toward construction applications, training will be allowed in lower-level management positions such as office engineers and estimators. Contractors shall submit new classifications for specific job functions that their employees are performing. The Department will review and recommend for acceptance to FHWA the new classifications proposed by contractors, if applicable. New classifications shall meet the following requirements:

Proposed training classifications are reasonable and realistic based on the job skill classification needs, and

The number of training hours specified in the training classification is consistent with common practices and provides enough time for the trainee to obtain journeyman level status.

The Contractor may allow trainees to be trained by a subcontractor provided that the Contractor retains primary responsibility for meeting the training and this provision is made applicable to the subcontract. However, only the Contractor will receive credit towards the annual goal for the trainee.

Where feasible, 25 percent of apprentices or trainees in each occupation shall be in their first year of apprenticeship or training. The number of trainees shall be distributed among the work classifications on the basis of the contractor's needs and the availability of journeymen in the various classifications within a reasonable area of recruitment.

No employee shall be employed as a trainee in any classification in which they have successfully completed a training course leading to journeyman level status or in which they have been employed as a journeyman.

### **Records and Reports**

The Contractor shall maintain enrollment, monthly and completion reports documenting company compliance under these contract documents. These documents and any other information as requested shall be submitted to the OJT Program Manager.

Upon completion and graduation of the program, the Contractor shall provide each trainee with a certification Certificate showing the type and length of training satisfactorily completed.

### **Trainee Interviews**

All trainees enrolled in the program will receive an initial and Trainee/Post graduate interview conducted by the OJT program staff.

### **Trainee Wages**

Contractors shall compensate trainees on a graduating pay scale based upon a percentage of the prevailing minimum journeyman wages (Davis-Bacon Act). Minimum pay shall be as follows:

60 percent	of the journeyman wage for the first half of the training period
75 percent	of the journeyman wage for the third quarter of the training period
90 percent	of the journeyman wage for the last quarter of the training period

In no instance shall a trainee be paid less than the local minimum wage. The Contractor shall adhere to the minimum hourly wage rate that will satisfy both the NC Department of Labor (NCDOL) and the Department.

#### **Achieving or Failing to Meet Training Goals**

The Contractor will be credited for each trainee employed by him on the contract work who is currently enrolled or becomes enrolled in an approved program and who receives training for at least 50 percent of the specific program requirement. Trainees will be allowed to be transferred between projects if required by the Contractor's scheduled workload to meet training goals.

If a contractor fails to attain their training assignments for the calendar year, they may be taken off the NCDOT's Bidders List.

#### **Measurement and Payment**

No compensation will be made for providing required training in accordance with these contract documents.

**STANDARD SPECIAL PROVISION****MINIMUM WAGES****GENERAL DECISION NC20220086 01/07/2022 NC86**

Z-086

Date: January 7, 2022

General Decision Number: NC20220086 01/07/2022 NC86

Superseded General Decision Numbers: NC20210086

State: North Carolina

Construction Type: HIGHWAY

**COUNTIES:**

Alleghany	Jackson	Surry
Ashe	Lincoln	Swain
Avery	Macon	Transylvania
Cherokee	McDowell	Watauga
Clay	Mitchell	Wilkes
Cleveland	Polk	Yancey
Graham	Rutherford	

HIGHWAY CONSTRUCTION PROJECTS (excluding tunnels, building structures in rest area projects & railroad construction; bascule, suspension & spandrel arch bridges designed for commercial navigation, bridges involving marine construction; and other major bridges).

Note: Contracts subject to the Davis-Bacon Act are generally required to pay at least the applicable minimum wage rate required under Executive Order 14026 or Executive Order 13658. Please note that these Executive Orders apply to covered contracts entered into by the federal government that are subject to the Davis-Bacon Act itself, but do not apply to contracts subject only to the Davis-Bacon Related Acts, including those set forth at 29 CFR 5.1(a)(2)-(60).

If the contract is entered into on or after January 30, 2022, or the contract is renewed or extended (e.g., an option is exercised) on or after January 30, 2022, Executive Order 14026 generally applies to the contract. The contractor must pay all covered workers at least \$15.00 per hour (or the applicable wage rate listed on this wage determination, if it is higher) for all hours spent performing on that contract in 2022.

If the contract was awarded on or between January 1, 2015 and January 29, 2022, and the contract is not renewed or extended on or after January 30, 2022, Executive Order 13658 generally applies to the contract. The contractor must pay all covered workers at least \$11.25 per hour (or the applicable wage rate listed on this wage determination, if it is higher) for all hours spent performing on that contract in 2022.

The applicable Executive Order minimum wage rate will be adjusted annually. If this contract is covered by one of the Executive Orders and a classification considered necessary for performance

of work on the contract does not appear on this wage determination, the contractor must still submit a conformance request.

Additional information on contractor requirements and worker protections under the Executive Orders is available at [www.dol.gov/whd/govcontracts](http://www.dol.gov/whd/govcontracts).

Modification Number

0

Publication Date

01/07/2022

SUNC2014-001 11/13/2014

	Rates	Fringes
BLASTER	21.83	
CARPENTER	12.54	
CEMENT MASON/CONCRETE FINISHER	14.10	
ELECTRICIAN		
Electrician	19.19	2.39
Telecommunications Technician	15.13	
IRONWORKER	14.53	
LABORER		
Asphalt Raker and Spreader	12.23	
Asphalt Screed/Jackman	15.22	
Carpenter Tender	10.00	
Cement Mason/Concrete Finisher Tender	12.26	
Common or General	10.68	
Guardrail/Fence Installer	13.43	
Pipelayer	12.22	
Traffic Signal/Lighting Installer	15.85	
PAINTER		
Bridge	19.62	
POWER EQUIPMENT OPERATORS		
Asphalt Broom Tractor	11.00	
Bulldozer Fine	16.20	
Bulldozer Rough	13.89	
Concrete Grinder/Groover	24.66	
Crane Boom Trucks	14.44	.53
Crane Other	19.59	
Crane Rough/All-Terrain	21.25	
Drill Operator Rock	15.25	
Drill Operator Structure	20.92	
Excavator Fine	16.11	
Excavator Rough	13.10	
Grader/Blade Fine	19.24	
Grader/Blade Rough	13.07	
Loader 2 Cubic Yards or Less	13.38	
Loader Greater Than 2 Cubic Yards	16.01	
Material Transfer Vehicle (Shuttle Buggy)	17.39	
Mechanic	18.51	
Milling Machine	13.88	
Off-Road Hauler/Water Tanker	13.87	
Oiler/Greaser	14.98	
Pavement Marking Equipment	13.33	

	Rates	Fringes
Paver Asphalt	15.68	.05
Roller Asphalt Breakdown	14.05	.06
Roller Asphalt Finish	14.98	.04
Roller Other	11.75	
Scraper Finish	13.87	
Scraper Rough	11.53	
Slip Form Machine	20.79	
Tack Truck/Distributor Operator	14.67	.06
TRUCK DRIVER		
GVWR of 26,000 Lbs or Less	11.72	
GVWR of 26,001 Lbs or Greater	13.50	

Welders – Receive rate prescribed for craft performing operation to which welding is incidental.

Note: Executive Order (EO) 13706, Establishing Paid Sick Leave for Federal Contractors applies to all contracts subject to the Davis-Bacon Act for which the contract is awarded (and any solicitation was issued) on or after January 1, 2017. If this contract is covered by the EO, the contractor must provide employees with 1 hour of paid sick leave for every 30 hours they work, up to 56 hours of paid sick leave each year. Employees must be permitted to use paid sick leave for their own illness, injury or other health-related needs, including preventive care; to assist a family member (or person who is like family to the employee) who is ill, injured, or has other health-related needs, including preventive care; or for reasons resulting from, or to assist a family member (or person who is like family to the employee) who is a victim of, domestic violence, sexual assault, or stalking. Additional information on contractor requirements and worker protections under the EO is available at [www.dol.gov/whd/govcontracts](http://www.dol.gov/whd/govcontracts).

Unlisted classifications needed for work not included within the scope of the classifications listed may be added after award only as provided in the labor standards contract clauses (29 CFR 5.5(a)(1)(ii)).

The body of each wage determination lists the classification and wage rates that have been found to be prevailing for the cited type(s) of construction in the area covered by the wage determination. The classifications are listed in alphabetical order of "identifiers" that indicate whether the particular rate is a union rate (current union negotiated rate for local), a survey rate (weighted average rate) or a union average rate (weighted union average rate).

#### Union Rate Identifiers

A four letter classification abbreviation identifier enclosed in dotted lines beginning with characters other than "SU" or "UAVG" denotes that the union classification and rate were prevailing for that classification in the survey. Example: PLUM0198-005 07/01/2014. PLUM is an abbreviation identifier of the union which prevailed in the survey for this classification, which in this example would be Plumbers. 0198 indicates the local union number or district council number where applicable, i.e., Plumbers Local 0198. The next number, 005 in the example, is an internal number used in processing the wage determination. 07/01/2014 is the effective date of the most current negotiated rate, which in this example is July 1, 2014.



Union prevailing wage rates are updated to reflect all rate changes in the collective bargaining agreement (CBA) governing this classification and rate.

#### Survey Rate Identifiers

Classifications listed under the "SU" identifier indicate that no one rate prevailed for this classification in the survey and the published rate is derived by computing a weighted average rate based on all the rates reported in the survey for that classification. As this weighted average rate includes all rates reported in the survey, it may include both union and non-union rates. Example: SULA2012-007 5/13/2014. SU indicates the rates are survey rates based on a weighted average calculation of rates and are not majority rates. LA indicates the State of Louisiana. 2012 is the year of survey on which these classifications and rates are based. The next number, 007 in the example, is an internal number used in producing the wage determination. 5/13/2014 indicates the survey completion date for the classifications and rates under that identifier.

Survey wage rates are not updated and remain in effect until a new survey is conducted.

#### Union Average Rate Identifiers

Classification(s) listed under the UAVG identifier indicate that no single majority rate prevailed for those classifications; however, 100% of the data reported for the classifications was union data. EXAMPLE: UAVG-OH-0010 08/29/2014. UAVG indicates that the rate is a weighted union average rate. OH indicates the state. The next number, 0010 in the example, is an internal number used in producing the wage determination. 08/29/2014 indicates the survey completion date for the classifications and rates under that identifier.

A UAVG rate will be updated once a year, usually in January of each year, to reflect a weighted average of the current negotiated/CBA rate of the union locals from which the rate is based.

#### WAGE DETERMINATION APPEALS PROCESS

1.) Has there been an initial decision in the matter? This can be:

- \* an existing published wage determination
- \* a survey underlying a wage determination
- \* a Wage and Hour Division letter setting forth a position on a wage determination matter
- \* a conformance (additional classification and rate) ruling

On survey related matters, initial contact, including requests for summaries of surveys, should be with the Wage and Hour Division National Office Branch of Wage Surveys. If the response from this initial contact is not satisfactory, then the process described in 2.) and 3.) should be followed.

With regard to any other matter not yet ripe for the formal process described here, initial contact should be with the Branch of Construction Wage Determinations. Write to:

Branch of Construction Wage Determinations  
Wage and Hour Division  
U. S. Department of Labor  
200 Constitution Avenue, N.W.  
Washington, D.C. 20210

- 2.) If the answer to the question in 1.) is yes, then an interested party (those affected by the action) can request review and reconsideration from the Wage and Hour Administrator (See 29 CFR Part 1.8 and 29 CFR Part 7). Write to:

Wage and Hour Administrator  
U.S. Department of Labor  
200 Constitution Avenue, N.W.  
Washington, D.C. 20210

The request should be accompanied by a full statement of the interested party's position and by any information (wage payment data, project description, area practice material, etc.) that the requestor considers relevant to the issue.

- 3.) If the decision of the Administrator is not favorable, an interested party may appeal directly to the Administrative Review Board (formerly the Wage Appeals Board). Write to:

Administrative Review Board  
U.S. Department of Labor  
200 Constitution Avenue, N.W.  
Washington, D.C. 20210

- 4.) All decisions by the Administrative Review Board are final.

END OF GENERAL DECISION

**PROJECT SPECIAL PROVISIONS****EROSION CONTROL****BORROW PIT DEWATERING BASIN:**

(3-17-09) (Rev 3-2-11)

**Description**

Water discharge from borrow pit sites shall not cause surface waters to exceed 50 NTUs (nephelometric turbidity unit) in streams not designated as trout waters and 10 NTUs in streams, lakes or reservoirs designated as trout waters. For lakes and reservoirs not designated as trout waters, the turbidity shall not exceed 25 NTUs. If the turbidity exceeds these levels due to natural background conditions, the existing turbidity level shall not be increased.

Construct, maintain and remove earth embankments used to reduce turbidity from dewatering borrow sites. Work includes providing porous coir fiber baffle, filtration geotextile, stone and outlet structures; cleaning out, maintaining, removing and disposing of the borrow pit dewatering basin and all components; and reshaping, dressing, seeding and mulching the area.

**Materials**

Refer to Division 10

<b>Item</b>	<b>Section</b>
Riprap, Class A, B, 1, and 2	1042
Geotextile for Drainage, Type 2	1056
Coir Fiber Baffle	1640-2

Use suitable excavated materials, as specified in Sections 225, 230 and 240 of the *Standard Specifications* in the construction of earth embankments for borrow pit dewatering basins, except where otherwise specified.

**Construction Methods**

Construct borrow pit dewatering basins according to the detail in the erosion control plans, and at locations shown on Reclamation Plans or in areas as directed.

The volume of the borrow pit dewatering basin will be based on a 2 hour retention time. The pump rate shall not exceed 1,000 GPM. The Contractor, at his option, may use a greater retention time for managing turbidity.

The straight line distance between the inlet and outlet shall be divided to include a forebay chamber in the upper quarter cell. Install one porous coir fiber baffle across the full width of the basin to delineate the forebay chamber. Do not use earthen or rock baffle. Install filtration geotextile on the interior side slopes and the floor of the forebay.

The water pumped from the borrow pit into the dewatering basin shall be obtained from the top of the water column and shall be discharged into the forebay in a non-erodible manner.

The borrow pit dewatering basin outlet shall be a vertical non-perforated riser pipe or flash board riser attached with a watertight connection to a barrel that carries the water through the embankment.

### **Maintenance and Removal**

Maintain the borrow pit dewatering basin, coir fiber baffle, and remove and dispose of silt accumulations in accordance with Article 1630-3 of the *Standard Specifications*. The Contractor may include a drain device for maintenance and removal at his discretion.

Remove the borrow pit dewatering basin once dewatering operations are completed. Grade, seed, and mulch the area after removal of the borrow pit dewatering basin in accordance with Section 1660 of the *Standard Specifications*. The area shall be stabilized with an approved groundcover before final acceptance of the site.

### **Measurement and Payment**

No direct payment will be made for borrow pit dewatering basins with the exception of the work of silt removal during dewatering basin operation and the work of seeding and mulching after removal of the dewatering basin. All other work and materials required for installation, maintenance and removal of borrow pit dewatering basins shall be incidental to *Borrow Excavation*. Such price and payments will be full compensation for the work of constructing, maintaining and removing the borrow pit dewatering basin including, but not limited to, the construction and removal of the borrow pit dewatering basin; furnishing of the outlet structure, baffle, filtration geotextile, stone and optional drain devices; and removal of all such items once dewatering operations are completed.

Removal and disposal of silt accumulations during dewatering operations will be measured and paid at the contract unit price per cubic yard for *Silt Excavation* in accordance with Article 1630-4 of the *Standard Specifications*.

Grading, seeding, and mulching the area after removal of the borrow pit dewatering basin will be measured and paid at the contract unit price per acre for *Seeding and Mulching* in accordance with Section 1660-8 of the *Standard Specifications*.

### **COIR FIBER WATTLES WITH POLYACRYLAMIDE (PAM):**

#### **Description**

Coir Fiber Wattles are tubular products consisting of coir fibers (coconut fibers) encased in coir fiber netting. Coir Fiber Wattles are used on slopes or channels to intercept runoff and act as a velocity break. Coir Fiber Wattles are to be placed at locations shown on the plans or as directed.

Installation shall follow the detail provided in the plans and as directed. Work includes furnishing materials, installation of coir fiber wattles, matting installation, PAM application, and removing wattles.

### Materials

Coir Fiber Wattle shall meet the following specifications:

100% Coir (Coconut) Fibers	
Minimum Diameter	12 in.
Minimum Density	3.5 lb/ft <sup>3</sup> +/- 10%
Net Material	Coir Fiber
Net Openings	2 in. x 2 in.
Net Strength	90 lbs.
Minimum Weight	2.6 lbs./ft. +/- 10%

Anchors: Stakes shall be used as anchors.

#### Wooden Stakes:

Provide hardwood stakes a minimum of 2-ft. long with a 2 in. x 2 in. nominal square cross section. One end of the stake must be sharpened or beveled to facilitate driving down into the underlying soil.

Matting shall meet the requirements of Article 1060-8 of the *Standard Specifications*, or shall meet specifications provided elsewhere in this contract.

Provide staples made of 0.125" diameter new steel wire formed into a *u* shape not less than 12" in length with a throat of 1" in width.

Polyacrylamide (PAM) shall be applied in powder form and shall be anionic or neutrally charged. Soil samples shall be obtained in areas where the wattles will be placed, and from offsite material used to construct the roadway, and analyzed for the appropriate PAM flocculant to be utilized with each wattle. The PAM product used shall be listed on the North Carolina Department of Environmental Quality Division of Water Resources web site as an approved PAM product for use in North Carolina.

### Construction Methods

Coir Fiber Wattles shall be secured to the soil by wire staples approximately every 1 linear foot and at the end of each section of wattle. A minimum of 4 stakes shall be installed on the downstream side of the wattle with a maximum spacing of 2 linear feet along the wattle, and according to the detail. Install a minimum of 2 stakes on the upstream side of the wattle according to the detail provided in the plans. Stakes shall be driven into the ground a minimum of 10 in. with no more than 2 in. projecting from the top of the wattle. Drive stakes at an angle according to the detail provided in the plans.

Only install coir fiber wattle(s) to a height in ditch so flow will not wash around wattle and scour ditch slopes and according to the detail provided in the plans and as directed. Overlap adjoining sections of wattles a minimum of 6 in.

Installation of matting shall be in accordance with the detail provided in the plans, and in accordance with Article 1631-3 of the *Standard Specifications*, or in accordance with specifications provided elsewhere in this contract.

Apply PAM over the lower center portion of the coir fiber wattle where the water is going to flow over at a rate of 2 ounces per wattle, and 1 ounce of PAM on matting on each side of the wattle. PAM applications shall be done during construction activities after every rainfall event that is equal to or exceeds 0.50 in.

The Contractor shall maintain the coir fiber wattles until the project is accepted or until the wattles are removed, and shall remove and dispose of silt accumulations at the wattles when so directed in accordance with the requirements of Section 1630 of the *Standard Specifications*.

### **Measurement and Payment**

*Coir Fiber Wattles* will be measured and paid for by the actual number of linear feet of wattles which are installed and accepted. Such price and payment will be full compensation for all work covered by this section, including, but not limited to, furnishing all materials, labor, equipment and incidentals necessary to install the *Coir Fiber Wattles*.

Matting will be measured and paid for in accordance with Article 1631-4 of the *Standard Specifications*, or in accordance with specifications provided elsewhere in this contract.

*Polyacrylamide(PAM)* will be measured and paid for by the actual weight in pounds of PAM applied to the coir fiber wattles. Such price and payment will be full compensation for all work covered by this section, including, but not limited to, furnishing all materials, labor, equipment and incidentals necessary to apply the *Polyacrylamide(PAM)*.

Payment will be made under:

<b>Pay Item</b>	<b>Pay Unit</b>
Polyacrylamide(PAM)	Pound
Coir Fiber Wattle	Linear Foot

**CONCRETE WASHOUT STRUCTURE:**

(12-10-20)

**Description**

Concrete washout structures are enclosures above or below grade to contain concrete waste water and associated concrete mix from washing out ready-mix trucks, drums, pumps, or other equipment. Concrete washouts must collect and retain all the concrete washout water and solids, so that this material does not migrate to surface waters or into the ground water. These enclosures are not intended for concrete waste not associated with wash out operations.

The concrete washout structure may include constructed devices above or below ground and or commercially available devices designed specifically to capture concrete wash water.

**Materials**

<b>Item</b>	<b>Section</b>
Temporary Silt Fence	1605

*Safety Fence* shall meet the specifications as provided elsewhere in this contract.

Geomembrane basin liner shall meet the following minimum physical properties for low permeability; it shall consist of a polypropylene or polyethylene 10 mil think geomembrane. If the minimum setback dimensions can be achieved the liner is not required. (5 feet above groundwater, 50 feet from top of bank of perennial stream, other surface water body, or wetland.)

**Construction Methods**

Build an enclosed earthen berm or excavate to form an enclosure in accordance with the details and as directed.

Install temporary silt fence around the perimeter of the enclosure in accordance with the details and as directed if structure is not located in an area where existing erosion and sedimentation control devices are capable to containing any loss of sediment.

Post a sign with the words "Concrete Washout" in close proximity of the concrete washout area, so it is clearly visible to site personnel. Install safety fence as directed for visibility to construction traffic.

The construction details for the above grade and below grade concrete washout structures can be found on the following web page link:

<https://connect.ncdot.gov/resources/roadside/SoilWaterDocuments/ConcreteWashoutStructuredetail.pdf>

Alternate details for accommodating concrete washout may be submitted for review and approval.

The alternate details shall include the method used to retain and dispose of the concrete waste water within the project limits and in accordance with the minimum setback requirements. (5 feet above groundwater, 50 feet from top of bank of perennial stream, other surface water body, or wetland.)

### **Maintenance and Removal**

Maintain the concrete washout structure(s) to provide adequate holding capacity plus a minimum freeboard of 12 inches. Remove and dispose of hardened concrete and return the structure to a functional condition after reaching 75% capacity.

Inspect concrete washout structures for damage and maintain for effectiveness.

Remove the concrete washout structures and sign upon project completion. Grade the earth material to match the existing contours and permanently seed and mulch area.

### **Measurement and Payment**

*Concrete Washout Structure* will be paid for per each enclosure installed in accordance with the details. If alternate details or commercially available devices are approved, then those devices will also be paid for per each approved and installed device.

*Temporary Silt Fence* will be measured and paid for in accordance with Article 1605-5 of the *Standard Specifications*.

*Safety Fence* shall be measured and paid for as provided elsewhere in this contract.

No measurement will be made for other items or for over excavation or stockpiling.

Payment will be made under:

#### **Pay Item**

Concrete Washout Structure

#### **Pay Unit**

Each



**CONSTRUCTION MATERIALS MANAGEMENT:**

(3-19-19) (rev. 04-24-19)

**Description**

The requirements set forth shall be adhered to in order to meet the applicable materials handling requirements of the NCG010000 permit. Structural controls installed to manage construction materials stored or used on site shall be shown on the E&SC Plan. Requirements for handling materials on construction sites shall be as follows:

**Polyacrylamides (PAMS) and Flocculants**

Polyacrylamides (PAMS) and flocculants shall be stored in leak-proof containers that are kept under storm-resistant cover or surrounded by secondary containment structures designed to protect adjacent surface waters. PAMS or other flocculants used shall be selected from the NC DWR List of Approved PAMS/Flocculants. The concentration of PAMS and other flocculants used shall not exceed those specified in the NC DWR List of Approved PAMS/Flocculants and in accordance with the manufacturer's instructions. The NC DWR List of Approved PAMS/Flocculants is available at:

[https://files.nc.gov/ncdeq/Water%20Quality/Environmental%20Sciences/ATU/ApprovedPAMS\\_4\\_1\\_2017.pdf](https://files.nc.gov/ncdeq/Water%20Quality/Environmental%20Sciences/ATU/ApprovedPAMS_4_1_2017.pdf)

**Equipment Fluids**

Fuels, lubricants, coolants, and hydraulic fluids, and other petroleum products shall be handled and disposed of in a manner so as not to enter surface or ground waters and in accordance with applicable state and federal regulations. Equipment used on the site must be operated and maintained properly to prevent discharge of fluids. Equipment, vehicle, and other wash waters shall not be discharged into E&SC basins or other E&SC devices. Alternative controls should be provided such that there is no discharge of soaps, solvents, or detergents.

**Waste Materials**

Construction materials and land clearing waste shall be disposed of in accordance with North Carolina General Statutes, Chapter 130A, Article 9 - Solid Waste Management, and rules governing the disposal of solid waste (15A NCAC 13B). Areas dedicated for managing construction material and land clearing waste shall be at least 50 feet away from storm drain inlets and surface waters unless it can be shown that no other alternatives are reasonably available. Paint and other liquid construction material waste shall not be dumped into storm drains. Paint and other liquid construction waste washouts should be located at least 50 feet away from storm drain inlets unless there is no alternative. Other options are to install lined washouts or use portable, removable bags or bins. Hazardous or toxic waste shall be managed in accordance with the federal Resource Conservation and Recovery Act (RCRA) and NC Hazardous Waste Rules at 15A NCAC, Subchapter 13A. Litter and sanitary waste shall be managed in a manner to prevent it from entering jurisdictional waters and shall be disposed of offsite.

**Herbicide, Pesticide, and Rodenticides**

Herbicide, pesticide, and rodenticides shall be stored and applied in accordance with the Federal Insecticide, Fungicide, and Rodenticide Act, North Carolina Pesticide Law of 1971 and labeling restrictions.

**Concrete Materials**

Concrete materials onsite, including excess concrete, must be controlled and managed to avoid contact with surface waters, wetlands or buffers. No concrete or cement slurry shall be discharged from the site. (Note that discharges from onsite concrete plants require coverage under a separate NPDES permit – NCG140000.) Concrete wash water shall be managed in accordance with the *Concrete Washout Structure* provision. Concrete slurry shall be managed and disposed of in accordance with *NCDOT DGS and HOS DCAR Distribution of Class A Residuals Statewide* (Permit No. WQ0035749). Any hardened concrete residue will be disposed of, or recycled on site, in accordance with state solid waste regulations.

**Earthen Material Stock Piles**

Earthen material stock piles shall be located at least 50 feet away from storm drain inlets and surface waters unless it can be shown that no other alternatives are reasonably available.

**Measurement and Payment**

Conditions set within the *Construction Materials Management* provision are incidental to the project for which no direct compensation will be made.

**ENVIRONMENTALLY SENSITIVE AREAS:****Description**

This project is located in an *Environmentally Sensitive Area*. This designation requires special procedures to be used for clearing and grubbing, temporary stream crossings, and grading operations within the Environmentally Sensitive Areas identified on the plans and as designated by the Engineer. This also requires special procedures to be used for seeding and mulching and staged seeding within the project.

The Environmentally Sensitive Area shall be defined as a 50-foot buffer zone on both sides of the stream or depression measured from top of streambank or center of depression.

**Construction Methods****(A) Clearing and Grubbing**

In areas identified as Environmentally Sensitive Areas, the Contractor may perform clearing operations, but not grubbing operations until immediately prior to beginning

grading operations as described in Article 200-1 of the *Standard Specifications*. Only clearing operations (not grubbing) shall be allowed in this buffer zone until immediately prior to beginning grading operations. Erosion control devices shall be installed immediately following the clearing operation.

(B) Grading

Once grading operations begin in identified Environmentally Sensitive Areas, work shall progress in a continuous manner until complete. All construction within these areas shall progress in a continuous manner such that each phase is complete and areas are permanently stabilized prior to beginning of next phase. Failure on the part of the Contractor to complete any phase of construction in a continuous manner in Environmentally Sensitive Areas will be just cause for the Engineer to direct the suspension of work in accordance with Article 108-7 of the *Standard Specifications*.

(C) Temporary Stream Crossings

Any crossing of streams within the limits of this project shall be accomplished in accordance with the requirements of Subarticle 107-12 of the *Standard Specifications*.

(D) Seeding and Mulching

Seeding and mulching shall be performed in accordance with Section 1660 of the *Standard Specifications* and vegetative cover sufficient to restrain erosion shall be installed immediately following grade establishment.

Seeding and mulching shall be performed on the areas disturbed by construction immediately following final grade establishment. No appreciable time shall lapse into the contract time without stabilization of slopes, ditches and other areas within the Environmentally Sensitive Areas.

(E) Stage Seeding

The work covered by this section shall consist of the establishment of a vegetative cover on cut and fill slopes as grading progresses. Seeding and mulching shall be done in stages on cut and fill slopes that are greater than 20 feet in height measured along the slope, or greater than 2 acres in area. Each stage shall not exceed the limits stated above.

Additional payments will not be made for the requirements of this section, as the cost for this work shall be included in the contract unit prices for the work involved.

**FABRIC INSERT INLET PROTECTION DEVICE (HIGH FLOW)**

(6-29-17)

**Description**

This work shall consist of installing, maintaining, and removing *Fabric Inlet Protection Device*, of the type specified, in inlet structures (catch basins, drop inlets, etc) in areas where asphalt or concrete may prevent the proper installation of a Rock Inlet Sediment Traps Type C, or as directed.

**Materials**

The product shall be a fabric inlet protection device composed of a fitted woven polypropylene geotextile double sewn with nylon thread suspended sack. The *Fabric Inlet Protection Device* shall be manufactured to fit the opening of the catch basin or drop inlet or shall have a deflector to direct runoff from the curb opening into the fabric sack. The *Fabric Inlet Protection Device* shall have a rigid frame or support system to support the loaded weight of the product. The product shall have lifting loops for removing the device from the basin and will have dump straps attached at the bottom to facilitate the emptying of the device. The *Fabric Inlet Protection Device* shall have an overflow system to allow stormwater to enter the inlet structure and avoid ponding on the roadway when the device reaches capacity

The stitching shall meet the following physical properties:

<b>Physical</b>	<b>Test Method</b>	<b>English</b>
Average Wide Width Strength	ASTM D-4884	165 lb/in

The fitted filter assembly shall have the following physical properties:

<b>Physical</b>	<b>Test Method</b>	<b>English</b>
Grab Tensile	ASTM D-4632	255 x 275 lbs
Minimum Puncture Strength	ASTM D-4833	125 lbs
Mullen Burst	ASTM D-3786	420 PSI
Minimum UV Resistance	ASTM D-4355	70 %.
Flow Rate	ASTM D-4491	200 gal/min/ft <sup>2</sup>
Apparent Opening	ASTM D-4751	20 US Sieve
Permittivity	ASTM D-4491	1.5 sec <sup>-1</sup>

**Construction Methods**

Strictly comply with manufacturer's installation instructions and recommendations. Maintenance shall include regular daily inspections and after each qualifying rain event. The *Fabric Inlet Protection Device* shall be emptied, cleaned and placed back into the basin when it reaches 50% capacity or as directed.

### Measurement and Payment

This work will be paid for at the contract unit price per *Fabric Insert Inlet Protection Device* of the type specified, complete in place and accepted. Such payment shall be full compensation for furnishing and installing the *Fabric Insert Inlet Protection Device* in accordance with this specification and for all required maintenance.

Maintenance of the device, cleanout and disposal of accumulated sediments shall be paid for by *Fabric Insert Inlet Protection Device Cleanout*.

Payment will be made under:

<b>Pay Item</b>	<b>Pay Unit</b>
Fabric Insert Inlet Protection Device	Each
Fabric Insert Inlet Protection Device Cleanout	Each

### MINIMIZE REMOVAL OF VEGETATION:

The Contractor shall minimize removal of vegetation within project limits to the maximum extent practicable. Vegetation along stream banks and adjacent to other jurisdictional resources outside the construction limits shall only be removed upon approval of Engineer. No additional payment will be made for this minimization work.

### RESPONSE FOR EROSION CONTROL:

#### Description

Furnish the labor, materials, tools and equipment necessary to move personnel, equipment, and supplies to the project necessary for the pursuit of any or all of the following work as shown herein, by an approved subcontractor.

<b>Section</b>	<b>Erosion Control Item</b>	<b>Unit</b>
1605	Temporary Silt Fence	LF
1606	Special Sediment Control Fence	LF/TON
1615	Temporary Mulching	ACR
1620	Seed - Temporary Seeding	LB
1620	Fertilizer - Temporary Seeding	TN
1631	Matting for Erosion Control	SY
SP	Coir Fiber Mat	SY
1640	Coir Fiber Baffles	LF
SP	Permanent Soil Reinforcement Mat	SY

1660	Seeding and Mulching	ACR
1661	Seed - Repair Seeding	LB
1661	Fertilizer - Repair Seeding	TON
1662	Seed - Supplemental Seeding	LB
1665	Fertilizer Topdressing	TON
SP	Safety/Highly Visible Fencing	LF
SP	Response for Erosion Control	EA

**Construction Methods**

Provide an approved subcontractor who performs an erosion control action as described in the NPDES Inspection Form SPPP30. Each erosion control action may include one or more of the above work items.

**Measurement and Payment**

*Response for Erosion Control* will be measured and paid for by counting the actual number of times the subcontractor moves onto the project, including borrow and waste sites, and satisfactorily completes an erosion control action described in Form 1675. The provisions of Article 104-5 of the *Standard Specifications* will not apply to this item of work.

Payment will be made under:

<b>Pay Item</b>	<b>Pay Unit</b>
Response for Erosion Control	Each

**STABILIZATION REQUIREMENTS:**

(3-11-2016)

Stabilization for this project shall comply with the time frame guidelines as specified by the NCG-010000 general construction permit effective April 1, 2019 issued by the North Carolina Department of Environmental Quality Division of Water Resources. Temporary or permanent ground cover stabilization shall occur within 7 calendar days from the last land-disturbing activity, with the following exceptions in which temporary or permanent ground cover shall be provided in 14 calendar days from the last land-disturbing activity:

- Slopes between 2:1 and 3:1, with a slope length of 10 ft. or less
- Slopes 3:1 or flatter, with a slope of length of 50 ft. or less
- Slopes 4:1 or flatter

The stabilization timeframe for High Quality Water (HQW) Zones shall be 7 calendar days with no exceptions for slope grades or lengths. High Quality Water Zones (HQW) Zones are defined by North Carolina Administrative Code 15A NCAC 04A.0105 (25). Temporary and permanent

ground cover stabilization shall be achieved in accordance with the provisions in this contract and as directed.

**SEEDING AND MULCHING:**

(WestEd)

The kinds of seed and fertilizer, and the rates of application of seed, fertilizer, and limestone, shall be as stated below. During periods of overlapping dates, the kind of seed to be used shall be determined. All rates are in pounds per acre.

Shoulder and Median Areas

**August 1 - June 1**

20#	Kentucky Bluegrass
75#	Hard Fescue
25#	Rye Grain
500#	Fertilizer
4000#	Limestone

**May 1 - September 1**

20#	Kentucky Bluegrass
75#	Hard Fescue
10#	German or Browntop Millet
500#	Fertilizer
4000#	Limestone

Areas Beyond the Mowing Pattern, Waste and Borrow Areas:

**August 1 - June 1**

100#	Tall Fescue
15#	Kentucky Bluegrass
30#	Hard Fescue
25#	Rye Grain
500#	Fertilizer
4000#	Limestone

**May 1 - September 1**

100#	Tall Fescue
15#	Kentucky Bluegrass
30#	Hard Fescue
10#	German or Browntop Millet
500#	Fertilizer
4000#	Limestone

Approved Tall Fescue Cultivars

06 Dust	Escalade	Justice	Serengeti
2 <sup>nd</sup> Millennium	Essential	Kalahari	Shelby
3 <sup>rd</sup> Millennium	Evergreen 2	Kitty Hawk 2000	Sheridan
Apache III	Falcon IV	Legitimate	Signia
Avenger	Falcon NG	Lexington	Silver Hawk
Barlexas	Falcon V	LSD	Sliverstar
Barlexas II	Faith	Magellan	Shenandoah Elite
Bar Fa	Fat Cat	Matador	Sidewinder
Barrera	Festnova	Millennium SRP	Skyline
Barrington	Fidelity	Monet	Solara
Barrobusto	Finelawn Elite	Mustang 4	Southern Choice II
Barvado	Finelawn Xpress	Ninja 2	Speedway
Biltmore	Finesse II	Ol' Glory	Spyder LS
Bingo	Firebird	Olympic Gold	Sunset Gold
Bizem	Firecracker LS	Padre	Taccoa
Blackwatch	Firenza	Patagonia	Tanzania

Blade Runner II	Five Point	Pedigree	Trio
Bonsai	Focus	Picasso	Tahoe II
Braveheart	Forte	Piedmont	Talladega
Bravo	Garrison	Plantation	Tarheel
Bullseye	Gazelle II	Proseeds 5301	Terrano
Cannavaro	Gold Medallion	Prospect	Titan Ltd
Catalyst	Grande 3	Pure Gold	Titanium LS
Cayenne	Greenbrooks	Quest	Tracer
Cessane Rz	Greenkeeper	Raptor II	Traverse SRP
Chipper	Gremlin	Rebel Exeda	Tulsa Time
Cochise IV	Greystone	Rebel Sentry	Turbo
Constitution	Guardian 21	Rebel IV	Turbo RZ
Corgi	Guardian 41	Regiment II	Tuxedo RZ
Corona	Hemi	Regenerate	Ultimate
Coyote	Honky Tonk	Rendition	Venture
Darlington	Hot Rod	Rhambler 2 SRP	Umbrella
Davinci	Hunter	Rembrandt	Van Gogh
Desire	Inferno	Reunion	Watchdog
Dominion	Innovator	Riverside	Wolfpack II
Dynamic	Integrity	RNP	Xtremegreen
Dynasty	Jaguar 3	Rocket	
Endeavor	Jamboree	Scorpion	

## Approved Kentucky Bluegrass Cultivars:

4-Season	Blue Velvet	Gladstone	Quantum Leap
Alexa II	Blueberry	Granite	Rambo
America	Boomerang	Hampton	Rhapsody
Apollo	Brilliant	Harmonie	Rhythm
Arcadia	Cabernet	Impact	Rita
Aries	Champagne	Jefferson	Royce
Armada	Champlain	Juliet	Rubicon
Arrow	Chicago II	Jump Start	Rugby II
Arrowhead	Corsair	Keeneland	Shiraz
Aura	Courtyard	Langara	Showcase
Avid	Delight	Liberator	Skye
Award	Diva	Madison	Solar Eclipse
Awesome	Dynamo	Mercury	Sonoma
Bandera	Eagleton	Midnight	Sorbonne
Barduke	Emblem	Midnight II	Starburst
Barnique	Empire	Moon Shadow	Sudden Impact
Baroness	Envicta	Moonlight SLT	Total Eclipse
Barrister	Everest	Mystere	Touche
Barvette HGT	Everglade	Nu Destiny	Tsunami
Bedazzled	Excursion	NuChicago	Unique
Belissimo	Freedom II	NuGlade	Valor



Bewitched	Freedom III	Odyssey	Voyager II
Beyond	Front Page	Perfection	Washington
Blacksburg II	Futurity	Pinot	Zinfandel
Blackstone	Gaelic	Princeton 105	
Blue Note	Ginney II	Prosperity	

Approved Hard Fescue Cultivars:

Aurora II	Eureka II	Oxford	Scaldis II
Aurora Gold	Firefly	Reliant II	Spartan II
Berkshire	Granite	Reliant IV	Stonehenge
Bighorn GT	Heron	Rescue 911	
Chariot	Nordic	Rhino	

On cut and fill slopes 2:1 or steeper add 20# Sericea Lespedeza and 15# Crown Vetch January 1 - December 31.

The Crown Vetch Seed should be double inoculated if applied with a hand seeder. Four times the normal rate of inoculant should be used if applied with a hydroseeder. If a fertilizer-seed slurry is used, the required limestone should also be included to prevent fertilizer acidity from killing the inoculant bacteria. Caution should be used to keep the inoculant below 80° F to prevent harm to the bacteria. The rates and grades of fertilizer and limestone shall be the same as specified for *Seeding and Mulching*.

Fertilizer shall be 10-20-20 analysis. A different analysis of fertilizer may be used provided the 1-2-2 ratio is maintained and the rate of application adjusted to provide the same amount of plant food as a 10-20-20 analysis and as directed.

**TEMPORARY SEEDING:**

Fertilizer shall be the same analysis as specified for *Seeding and Mulching* and applied at the rate of 400 pounds and seeded at the rate of 50 pounds per acre. German Millet, or Browntop Millet shall be used in summer months and rye grain during the remainder of the year. The Engineer will determine the exact dates for using each kind of seed.

**FERTILIZER TOPDRESSING:**

Fertilizer used for topdressing shall be 16-8-8 grade and shall be applied at the rate of 500 pounds per acre. A different analysis of fertilizer may be used provided the 2-1-1 ratio is maintained and the rate of application adjusted to provide the same amount of plant food as 16-8-8 analysis and as directed.

**SUPPLEMENTAL SEEDING:**

The kinds of seed and proportions shall be the same as specified for *Seeding and Mulching*, and the rate of application may vary from 25# to 75# per acre. The actual rate per acre will be

determined prior to the time of topdressing and the Contractor will be notified in writing of the rate per acre, total quantity needed, and areas on which to apply the supplemental seed. Minimum tillage equipment, consisting of a sod seeder shall be used for incorporating seed into the soil as to prevent disturbance of existing vegetation. A clodbuster (ball and chain) may be used where degree of slope prevents the use of a sod seeder.

**MOWING:**

The minimum mowing height on this project shall be six inches.

**STOCKPILE AREAS:**

The Contractor shall install and maintain erosion control devices sufficient to contain sediment around any erodible material stockpile areas as directed.

**ACCESS AND HAUL ROADS:**

At the end of each working day, the Contractor shall install or re-establish temporary diversions or earth berms across access/haul roads to direct runoff into sediment devices. Silt fence sections that are temporarily removed shall be reinstalled across access/haul roads at the end of each working day.

**WASTE AND BORROW SOURCES:**

Payment for temporary erosion control measures, except those made necessary by the Contractor's own negligence or for his own convenience, will be paid for at the appropriate contract unit price for the devices or measures utilized in borrow sources and waste areas.

No additional payment will be made for erosion control devices or permanent seeding and mulching in any commercial borrow or waste pit. All erosion and sediment control practices that may be required on a commercial borrow or waste site will be done at the Contractor's expense.

All offsite Staging Areas, Borrow and Waste sites shall be in accordance with "Borrow and Waste Site Reclamation Procedures for Contracted Projects" located at:

<https://connect.ncdot.gov/resources/roadside/FieldOperationsDocuments/ContractedReclamationProcedures.pdf>

All forms and documents referenced in the "Borrow and Waste Site Reclamation Procedures for Contracted Projects" shall be included with the reclamation plans for offsite staging areas, and borrow and waste sites.

Signals and Intelligent Transportation Systems
Project Special Provisions
(Version 18.6)

Prepared By: RNZ
16-Dec-21

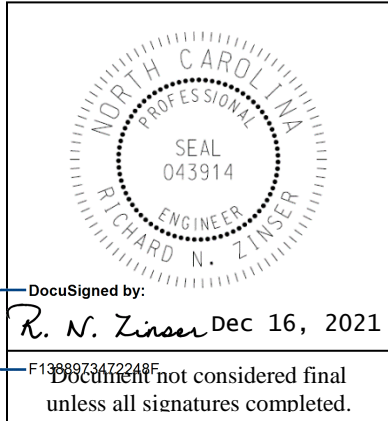

Contents

1. 2018 STANDARD SPECIFICATIONS FOR ROADS & STRUCTURES.....2
1.1. GENERAL REQUIREMENTS – CONSTRUCTION METHODS (1700-3(K)) .....2
1.2. GENERAL REQUIREMENTS – CONSTRUCTION METHODS (1700-3(M)).....2
1.3. WOOD POLES – CONSTRUCTION METHODS (1720-3) .....2
2. SIGNAL HEADS.....2
2.1. MATERIALS .....2
A. General: .....2
B. Vehicle Signal Heads:.....4
C. Signal Cable:.....7
3. CONTROLLERS WITH CABINETS .....7
3.1. MATERIALS – TYPE 170E CONTROLLERS .....7
3.2. MATERIALS – GENERAL CABINETS .....8
3.3. MATERIALS – TYPE 170E CABINETS .....9
A. Type 170 E Cabinets General: .....9
B. Type 170 E Cabinet Electrical Requirements: .....9
C. Type 170 E Cabinet Physical Requirements:.....16
D. Model 2018 Enhanced Conflict Monitor: .....19
3.4. MATERIALS – TYPE 170 DETECTOR SENSOR UNITS .....29
3.5. MATERIALS – TYPE 2070E CONTROLLERS .....29
4. MICROWAVE VEHICLE DETECTION SYSTEM - MULTIPLE DETECTION ZONES.....30
4.1. DESCRIPTION .....30
4.2. MATERIALS .....30
4.3. CONSTRUCTION METHODS .....31
4.4. MEASUREMENT AND PAYMENT .....31
5. METAL POLE SUPPORTS .....31
5.1. METAL POLES .....31
A. General: .....31
B. Materials: .....33
C. Design:.....35
D. Strain Poles: .....37
5.2. DRILLED PIER FOUNDATIONS FOR METAL POLES.....37
A. Description: .....38
B. Soil Test and Foundation Determination: .....39
C. Drilled Pier Construction: .....41
5.3. POLE NUMBERING SYSTEM .....41
A. New Poles .....41
5.4. MEASUREMENT AND PAYMENT .....41

## 2018 STANDARD SPECIFICATIONS FOR ROADS &amp; STRUCTURES

*The 2018 Standard Specifications are revised as follows:*

**1.1. GENERAL REQUIREMENTS – Construction Methods (1700-3(K))**

Page 17-4, revise sentence starting on line 14 to read “Modify existing electrical services, as necessary, to meet the grounding requirements of the NEC, these *Standard Specifications*, *Standard Drawings*, and the project plans.”

Page 17-4, revise sentence beginning on line 21 to read “Furnish and install additional ground rods to grounding electrode system as necessary to meet the *Standard Specifications*, *Standard Drawings*, and test requirements.”

**1.2. GENERAL REQUIREMENTS – Construction Methods (1700-3(M))**

Page 17-4, Replace the sentence beginning on line 41 with “Prior to placing signal in the steady (stop-and-go) mode, the signal should be placed in the flashing mode for up to 7 days or as directed by the Engineer. The signal should not be placed in the steady (stop-and-go) mode on a Saturday or Sunday without prior approval from the Engineer. Do not place the signal in steady (stop-and-go) mode until inspected and without the prior approval of the Engineer.”

**1.3. WOOD POLES – Construction Methods (1720-3)**

Page 17-18, revise sentence starting on line 13 to read “On new Department-owned poles, install a grounding system consisting of #6 AWG solid bare copper wire that is mechanically crimped using an irreversible compression tool with die to a single ground rod installed at base of pole or to the electrical service grounding electrode system located within 10 feet of the pole.”

**2. SIGNAL HEADS****2.1. MATERIALS****A. General:**

Fabricate vehicle signal head housings and end caps from die-cast aluminum. Fabricate 12-inch and 16-inch pedestrian signal head housings and end caps from die-cast aluminum. Fabricate 9-inch pedestrian signal head housings, end caps, and visors from virgin polycarbonate material. Provide visor mounting screws, door latches, and hinge pins fabricated from stainless steel. Provide interior screws, fasteners, and metal parts fabricated from stainless steel.

Fabricate tunnel and traditional visors from sheet aluminum.

Paint all surfaces inside and outside of signal housings and doors. Paint outside surfaces of tunnel and traditional visors, wire outlet bodies, wire entrance fitting brackets and end caps when supplied as components of messenger cable mounting assemblies, pole and pedestal mounting assemblies, and pedestrian pushbutton housings. Have electrostatically-applied, fused-polyester paint in highway yellow (Federal Standard 595C, Color Chip Number 13538) a minimum of 2.5 to 3.5 mils thick. Do not apply paint to the latching hardware, rigid vehicle signal head mounting brackets for mast-arm attachments, messenger cable hanger components or balance adjuster components.

Have the interior surfaces of tunnel and traditional visors painted an alkyd urea black synthetic baking enamel with a minimum gloss reflectance and meeting the requirements of MIL-E-10169, “Enamel Heat Resisting, Instrument Black.”

Where required, provide polycarbonate signal heads and visors that comply with the provisions pertaining to the aluminum signal heads listed on the QPL with the following exceptions:

Fabricate signal head housings, end caps, and visors from virgin polycarbonate material. Provide UV stabilized polycarbonate plastic with a minimum thickness of  $0.1 \pm 0.01$  inches that is highway yellow (Federal Standard 595C, Color Chip 13538). Ensure the color is incorporated into the plastic material before molding the signal head housings and end caps. Ensure the plastic formulation provides the following physical properties in the assembly (tests may be performed on separately molded specimens):

Test	Required	Method
Specific Gravity	1.17 minimum	ASTM D 792
Flammability	Self-extinguishing	ASTM D 635
Tensile Strength, yield, PSI	8500 minimum	ASTM D 638
Izod impact strength, ft-lb/in [notched, 1/8 inch]	12 minimum	ASTM D 256

For pole mounting, provide side of pole mounting assemblies with framework and all other hardware necessary to make complete, watertight connections of the signal heads to the poles and pedestals. Fabricate the mounting assemblies and frames from aluminum with all necessary hardware, screws, washers, etc. to be stainless steel. Provide mounting fittings that match the positive locking device on the signal head with the serrations integrally cast into the brackets. Provide upper and lower pole plates that have a 1 ¼-inch vertical conduit entrance hubs with the hubs capped on the lower plate and 1 ½-inch horizontal hubs. Ensure that the assemblies provide rigid attachments to poles and pedestals so as to allow no twisting or swaying of the signal heads. Ensure that all raceways are free of sharp edges and protrusions, and can accommodate a minimum of ten Number 14 AWG conductors.

For pedestal mounting, provide a post-top slipfitter mounting assembly that matches the positive locking device on the signal head with serrations integrally cast into the slipfitter. Provide stainless steel hardware, screws, washers, etc. Provide a minimum of six 3/8 X 3/4-inch long square head bolts for attachment to pedestal. Provide a center post for multi-way slipfitters.

For light emitting diode (LED) traffic signal modules, provide the following requirements for inclusion on the Department's Qualified Products List for traffic signal equipment.

1. Sample submittal,
2. Third-party independent laboratory testing results for each submitted module with evidence of testing and conformance with all of the Design Qualification Testing specified in section 6.4 of each of the following Institute of Transportation Engineers (ITE) specifications:
  - Vehicle Traffic Control Signal Heads – Light Emitting Diode (LED) Circular Signal Supplement
  - Vehicle Traffic Control Signal Heads – Light Emitting Diode (LED) Vehicle Arrow Traffic Signal Supplement
  - Pedestrian Traffic Control Signal Indications –Light Emitting Diode (LED) Signal Modules.

(Note: The Department currently recognizes two approved independent testing laboratories. They are Intertek ETL Semko and Light Metrics, Incorporated with Garwood Laboratories. Independent laboratory tests from other laboratories may be considered as part of the QPL submittal at the discretion of the Department,

3. Evidence of conformance with the requirements of these specifications,

4. A manufacturer's warranty statement in accordance with the required warranty, and
5. Submittal of manufacturer's design and production documentation for the model, including but not limited to, electrical schematics, electronic component values, proprietary part numbers, bill of materials, and production electrical and photometric test parameters.
6. Evidence of approval of the product to bear the Intertek ETL Verified product label for LED traffic signal modules.

In addition to meeting the performance requirements for the minimum period of 60 months, provide a written warranty against defects in materials and workmanship for the modules for a period of 60 months after installation of the modules. During the warranty period, the manufacturer must provide new replacement modules within 45 days of receipt of modules that have failed at no cost to the State. Repaired or refurbished modules may not be used to fulfill the manufacturer's warranty obligations. Provide manufacturer's warranty documentation to the Department during evaluation of product for inclusion on Qualified Products List (QPL).

#### **B. Vehicle Signal Heads:**

Comply with the ITE standard "Vehicle Traffic Control Signal Heads". Provide housings with provisions for attaching backplates.

Provide visors that are 8 inches in length for 8-inch vehicle signal head sections. Provide visors that are 10 inches in length for 12-inch vehicle signal heads.

Provide a termination block with one empty terminal for field wiring for each indication plus one empty terminal for the neutral conductor. Have all signal sections wired to the termination block. Provide barriers between the terminals that have terminal screws with a minimum Number 8 thread size and that will accommodate and secure spade lugs sized for a Number 10 terminal screw.

Mount termination blocks in the yellow signal head sections on all in-line vehicle signal heads. Mount the termination block in the red section on five-section vehicle signal heads.

Furnish vehicle signal head interconnecting brackets. Provide one-piece aluminum brackets less than 4.5 inches in height and with no threaded pipe connections. Provide hand holes on the bottom of the brackets to aid in installing wires to the signal heads. Lower brackets that carry no wires and are used only for connecting the bottom signal sections together may be flat in construction.

For messenger cable mounting, provide messenger cable hangers, wire outlet bodies, balance adjusters, bottom caps, wire entrance fitting brackets, and all other hardware necessary to make complete, watertight connections of the vehicle signal heads to the messenger cable. Fabricate messenger cable hanger components, wire outlet bodies and balance adjuster components from stainless steel or malleable iron galvanized in accordance with ASTM A153 (Class A) or ASTM A123. Provide serrated rings made of aluminum. Provide messenger cable hangers with U-bolt clamps. Fabricate washers, screws, hex-head bolts and associated nuts, clevis pins, cotter pins, U-bolt clamps and nuts from stainless steel.

For mast-arm mounting, provide rigid vehicle signal head mounting brackets and all other hardware necessary to make complete, watertight connections of the vehicle signal heads to the mast arms and to provide a means for vertically adjusting the vehicle signal heads to proper alignment. Fabricate the mounting assemblies from aluminum, and provide serrated rings made of aluminum. Provide stainless steel cable attachment assemblies to secure the brackets to the mast arms. Ensure all fastening hardware and fasteners are fabricated from stainless steel.

Provide LED vehicular traffic signal modules (hereafter referred to as modules) that consist of an assembly that uses LEDs as the light source in lieu of an incandescent lamp for use in traffic signal

sections. Use LEDs that are aluminum indium gallium phosphorus (AlInGaP) technology for red and yellow indications and indium gallium nitride (InGaN) for green indications. Install the ultra bright type LEDs that are rated for 100,000 hours of continuous operation from -40°F to +165°F. Design modules to have a minimum useful life of 60 months and to meet all parameters of this specification during this period of useful life.

For the modules, provide spade terminals crimped to the lead wires and sized for a #10 screw connection to the existing terminal block in a standard signal head. Do not provide other types of crimped terminals with a spade adapter.

Ensure the power supply is integral to the module assembly. On the back of the module, permanently mark the date of manufacture (month & year) or some other method of identifying date of manufacture.

Tint the red, yellow and green lenses to correspond with the wavelength (chromaticity) of the LED. Transparent tinting films are unacceptable. Provide a lens that is integral to the unit with a smooth outer surface.

### 1. LED Circular Signal Modules:

Provide modules in the following configurations: 12-inch circular sections, and 8-inch circular sections. All makes and models of LED modules purchased for use on the State Highway System shall appear on the current NCDOT Traffic Signal Qualified Products List (QPL).

Provide the manufacturer's model number and the product number (assigned by the Department) for each module that appears on the 2018 or most recent Qualified Products List. In addition, provide manufacturer's certification in accordance with Article 106-3 of the *Standard Specifications*, that each module meets or exceeds the ITE "Vehicle Traffic Control Signal Heads – Light Emitting Diode (LED) Circular Signal Supplement" dated June 27, 2005 (hereafter referred to as VTCSH Circular Supplement) and other requirements stated in this specification.

Provide modules that meet the following requirements when tested under the procedures outlined in the VTCSH Circular Supplement:

Module Type	Max. Wattage at 165° F	Nominal Wattage at 77° F
12-inch red circular	17	11
8-inch red circular	13	8
12-inch green circular	15	15
8-inch green circular	12	12

For yellow circular signal modules, provide modules tested under the procedures outlined in the VTCSH Circular Supplement to insure power required at 77° F is 22 Watts or less for the 12-inch circular module and 13 Watts or less for the 8-inch circular module.

Note: Use a wattmeter having an accuracy of  $\pm 1\%$  to measure the nominal wattage and maximum wattage of a circular traffic signal module. Power may also be derived from voltage, current and power factor measurements.

### 2. LED Arrow Signal Modules

Provide 12-inch omnidirectional arrow signal modules. All makes and models of LED modules purchased for use on the State Highway System shall appear on the current NCDOT Traffic Signal Qualified Products List (QPL).

Provide the manufacturer's model number and the product number (assigned by the Department) for each module that appears on the 2018 or most recent Qualified Products List. In addition, provide

manufacturer's certification in accordance with Article 106-3 of the *Standard Specifications*, that each module meets or exceeds the requirements for 12-inch omnidirectional modules specified in the ITE "Vehicle Traffic Control Signal Heads – Light Emitting Diode (LED) Vehicle Arrow Traffic Signal Supplement" dated July 1, 2007 (hereafter referred to as VTCSH Arrow Supplement) and other requirements stated in this specification.

Provide modules that meet the following requirements when tested under the procedures outlined in the VTCSH Arrow Supplement:

Module Type	Max. Wattage at 165° F	Nominal Wattage at 77° F
12-inch red arrow	12	9
12-inch green arrow	11	11

For yellow arrow signal modules, provide modules tested under the procedures outlined in the VTCSH Arrow Supplement to insure power required at 77° F is 12 Watts or less.

Note: Use a wattmeter having an accuracy of  $\pm 1\%$  to measure the nominal wattage and maximum wattage of an arrow traffic signal module. Power may also be derived from voltage, current and power factor measurements.

### 3. LED U-Turn Arrow Signal Modules:

Provide modules in the following configurations: 12-inch left u-turn arrow signal modules and 12-inch right u-turn arrow signal modules.

Modules are not required to be listed on the ITS and Signals Qualified Products List. Provide manufacturer's certification in accordance with Article 106-3 of the *Standard Specifications*, that each module meets or exceeds the ITE "Vehicle Traffic Control Signal Heads – Light Emitting Diode (LED) Circular Signal Supplement" dated June 27, 2005 (hereafter referred to as VTCSH Circular Supplement) and other requirements stated in this specification.

Provide modules that have minimum maintained luminous intensity values that are not less than 16% of the values calculated using the method described in section 4.1 of the VTCSH Circular Supplement.

Provide modules that meet the following requirements when tested under the procedures outlined in the VTCSH Circular Supplement:

Module Type	Max. Wattage at 165° F	Nominal Wattage at 77° F
12-inch red u-turn arrow	17	11
12-inch green u-turn arrow	15	15

For yellow u-turn arrow signal modules, provide modules tested under the procedures outlined in the VTCSH Circular Supplement to ensure power required at 77° F is 22 Watts or less.

Note: Use a wattmeter having an accuracy of  $\pm 1\%$  to measure the nominal wattage and maximum wattage of a circular traffic signal module. Power may also be derived from voltage, current and power factor measurements.

### 4. LED Bi-Modal Green-Yellow Arrow Signal Modules

Provide 12-inch omnidirectional bi-modal arrow signal modules. Ensure both green and yellow arrow indications are in each module with a clear lens that is integral to the unit. Ensure both indications display an incandescent style look.

Modules are not required to be listed on the ITS and Signals Qualified Products List. Ensure that both indications along with the module meet or exceed the requirements in sections 1, 2, 3, 4 and 5 of the VTCSH Arrow Supplement and other requirements stated in this specification.



Provide modules that meet the following requirements when tested under the procedures outlined in the VTCSH Arrow Supplement:

Arrow Type	Nominal Wattage at 77° F
12-inch yellow arrow	12
12-inch green arrow	11

Note: Use a wattmeter having an accuracy of  $\pm 1\%$  to measure the nominal wattage and maximum wattage of a circular traffic signal module. Power may also be derived from voltage, current and power factor measurements.

### C. Signal Cable:

Furnish 16-4 and 16-7 signal cable that complies with IMSA specification 20-1 except provide the following conductor insulation colors:

- For 16-4 cable: white, yellow, red, and green
- For 16-7 cable: white, yellow, red, green, yellow with black stripe tracer, red with black stripe tracer, and green with black stripe tracer. Apply continuous stripe tracer on conductor insulation with a longitudinal or spiral pattern.

Provide a ripcord to allow the cable jacket to be opened without using a cutter. IMSA specification 19-1 will not be acceptable. Provide a cable jacket labeled with the IMSA specification number and provide conductors constructed of stranded copper.

## 3. CONTROLLERS WITH CABINETS

### 3.1. MATERIALS – TYPE 170E CONTROLLERS

Conform to the CALTRANS *Traffic Signal Control Equipment Specifications* and addendum 8, *Specifications for Model 170E Enhanced Controller Unit and Associated Model 412C and Model 172 Modules* except as required herein.

Provide model 412C Program Modules as defined in CALTRANS Addendum 8 except as specified otherwise herein. Provide program module delivery with Memory Select #4 Configuration except that all RAM must be DALLAS Non-volatile RAM or an approved equal. Ensure that the removal of the program module from the controller will place the intersection into flash.

Provide diagnostic software or removable diagnostic PROM modules that will test and diagnose the following:

- systems of the controller, including the internal memory, Program Module, Real Time Clock, I/O circuitry, display, and keyboard;
- systems of the cabinet, including the output file, input file, police panel, flashing operation, and cabinet switches; and
- systems of the conflict monitor by checking all possible conflicts in a logical sequence and resetting the conflict monitor each time, and by testing red failure function and red detect cable disconnects.

Ensure that the automatic reset function can be enabled by inserting a diagnostic plug in the jack labeled “Conflict Monitor Test” in the “TEST” position.

In addition to CALTRANS system communications capability between a central computer and master controller and master to local controller communications, provide communications capability

with the intersection conflict monitor via an RS-232C/D port on the monitor. Ensure controller receives data from the conflict monitor through a controller Asynchronous Communications Interface Adapter (ACIA) determined by the controller software manufacturer. Ensure that with the appropriate software, the controller is capable of communicating directly through a laptop nine pin serial port to the same monitor RS-232C/D to retrieve all event log information.

Furnish a communications connecting cable with the following pin connections.

170		Conflict Monitor DB-9
RX pin L	Connect to	TX pin 2
TX pin K	Connect to	RX pin 3
+5 pin D	Connect to	DTR pin 4
GND pin N	Connect to	GND pin 5

Provide a male DB-9 connector on the cable for connection to the monitor.

Provide socket mounting for through-hole mount devices with 14 or more pins. Ensure that all sockets are AUGAT-500 series machined sockets, or equal.

Provide a moisture resistant coating on all circuit boards. Mount circuit boards vertically.

**3.2.MATERIALS – GENERAL CABINETS**

Provide a moisture resistant coating on all circuit boards.

Provide one 20 mm diameter radial lead UL-recognized metal oxide varistor (MOV) between each load switch field terminal and equipment ground. Electrical performance is outlined below.

PROPERTIES OF MOV SURGE PROTECTOR	
Maximum Continuous Applied Voltage at 185° F	150 VAC (RMS) 200 VDC
Maximum Peak 8x20µs Current at 185° F	6500 A
Maximum Energy Rating at 185° F	80 J
Voltage Range 1 mA DC Test at 77° F	212-268 V
Max. Clamping Voltage 8x20µs, 100A at 77° F	395 V
Typical Capacitance (1 MHz) at 77° F	1600 pF

Provide a power line surge protector that is a two-stage device that will allow connection of the radio frequency interference filter between the stages of the device. Ensure that a maximum continuous current is at least 10A at 120V. Ensure that the device can withstand a minimum of 20 peak surge current occurrences at 20,000A for an 8x20 microsecond waveform. Provide a maximum clamp voltage of 395V at 20,000A with a nominal series inductance of 200µh. Ensure that the voltage does not exceed 395V. Provide devices that comply with the following:

Frequency (Hz)	Minimum Insertion Loss (dB)
60	0
10,000	30
50,000	55
100,000	50
500,000	50
2,000,000	60
5,000,000	40
10,000,000	20
20,000,000	25

### 3.3. MATERIALS – TYPE 170E CABINETS

#### A. Type 170 E Cabinets General:

Conform to the city of Los Angeles' Specification No. 54-053-08, *Traffic Signal Cabinet Assembly Specification* (dated July 2008), except as required herein.

Furnish model 336S pole mounted cabinets configured for 8 vehicle phases, 4 pedestrian phases, and 6 overlaps. Do not reassign load switches to accommodate overlaps unless shown on electrical details. Provide 336S pole mounted cabinets that are 46" high with 40" high internal rack assemblies.

Furnish model 332 base mounted cabinets configured for 8 vehicle phases, 4 pedestrian phases, and 6 overlaps. When overlaps are required, provide auxiliary output files for the overlaps. Do not reassign load switches to accommodate overlaps unless shown on electrical details.

Provide model 200 load switches, model 222 loop detector sensors, model 252 AC isolators, and model 242 DC isolators according to the electrical details. As a minimum, provide one (1) model 2018 conflict monitor, one (1) model 206L power supply unit, two (2) model 204 flashers, one (1) DC isolator (located in slot I14), and four (4) model 430 flash transfer relays (provide seven (7) model 430 flash transfer relays if auxiliary output file is installed) with each cabinet.

#### B. Type 170 E Cabinet Electrical Requirements:

Provide a cabinet assembly designed to ensure that upon leaving any cabinet switch or conflict monitor initiated flashing operation, the controller starts up in the programmed start up phases and start up interval.

Furnish two sets of non-fading cabinet wiring diagrams and schematics in a paper envelope or container and placed in the cabinet drawer.

All AC+ power is subject to radio frequency signal suppression.

Provide surge suppression in the cabinet for each type of cabinet device. Provide surge protection for the full capacity of the cabinet input file. Provide surge suppression devices that operate properly over a temperature range of -40° F to +185° F. Ensure the surge suppression devices provide both common and differential modes of protection.

Provide a pluggable power line surge protector that is installed on the back of the PDA (power distribution assembly) chassis to filter and absorb power line noise and switching transients. Ensure

the device incorporates LEDs for failure indication and provides a dry relay contact closure for the purpose of remote sensing. Ensure the device meets the following specifications:

Peak Surge Current (Single pulse, 8x20µs).....	20,000A
Occurrences (8x20µs waveform).....	10 minimum @ 20,000A
Maximum Clamp Voltage.....	395VAC
Operating Current.....	15 amps
Response Time.....	< 5 nanoseconds

Provide a loop surge suppressor for each set of loop terminals in the cabinet. Ensure the device meets the following specifications:

Peak Surge Current (6 times, 8x20µs)	
(Differential Mode).....	400A
(Common Mode).....	1,000A
Occurrences (8x20µs waveform).....	500 min @ 200A
Maximum Clamp Voltage	
(Differential Mode @400A).....	35V
(Common Mode @1,000A).....	35V
Response Time.....	< 5 nanoseconds
Maximum Capacitance.....	35 pF

Provide a data communications surge suppressor for each communications line entering or leaving the cabinet. Ensure the device meets the following specifications:

Peak Surge Current (Single pulse, 8x20µs).....	10,000A
Occurrences (8x20µs waveform).....	100 min @ 2,000A
Maximum Clamp Voltage.....	Rated for equipment protected
Response Time.....	< 1 nanosecond
Maximum Capacitance.....	1,500 pF
Maximum Series Resistance.....	15Ω

Provide a DC signal surge suppressor for each DC input channel in the cabinet. Ensure the device meets the following specifications:

Peak Surge Current (Single pulse, 8x20µs).....	10,000A
Occurrences (8x20µs waveform).....	100 @ 2,000A
Maximum Clamp Voltage.....	30V
Response Time.....	< 1 nanosecond

Provide a 120 VAC signal surge suppressor for each AC+ interconnect signal input. Ensure the device meets the following specifications:

Peak Surge Current (Single pulse, 8x20µs).....	20,000A
Maximum Clamp Voltage.....	350VAC
Response Time.....	< 200 nanoseconds
Discharge Voltage.....	<200 Volts @ 1,000A
Insulation Resistance.....	≥100 MΩ

Provide conductors for surge protection wiring that are of sufficient size (ampacity) to withstand maximum overcurrents which could occur before protective device thresholds are attained and current flow is interrupted.

If additional surge protected power outlets are needed to accommodate fiber transceivers, modems, etc., install a UL listed, industrial, heavy-duty type power outlet strip with a minimum rating of 15 A / 125 VAC, 60 Hz. Provide a strip that has a minimum of 3 grounded outlets. Ensure the power outlet strip plugs into one of the controller unit receptacles located on the rear of the PDA. Ensure power outlet strip is mounted securely; provide strain relief if necessary.

Provide a door switch in the front and a door switch in the rear of the cabinet that will provide the controller unit with a Door Ajar alarm when either the front or the rear door is open. Ensure the door switches apply DC ground to the Input File when either the front door or the rear door is open.

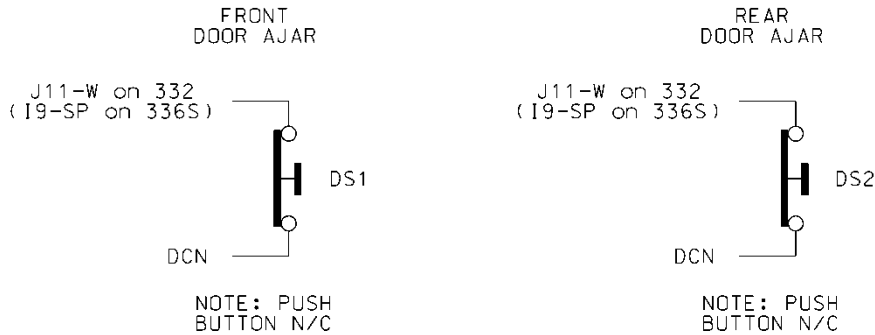

Furnish a fluorescent fixture in the rear across the top of the cabinet and another fluorescent fixture in the front across the top of the cabinet at a minimum. Ensure that the fixtures provide sufficient light to illuminate all terminals, labels, switches, and devices in the cabinet. Conveniently locate the fixtures so as not to interfere with a technician’s ability to perform work on any devices or terminals in the cabinet. Provide a protective diffuser to cover exposed bulbs. Install 16 watt T-4 lamps in the fluorescent fixtures. Provide a door switch to provide power to each fixture when the respective door is open. Wire the fluorescent fixtures to the 15 amp ECB (equipment circuit breaker).

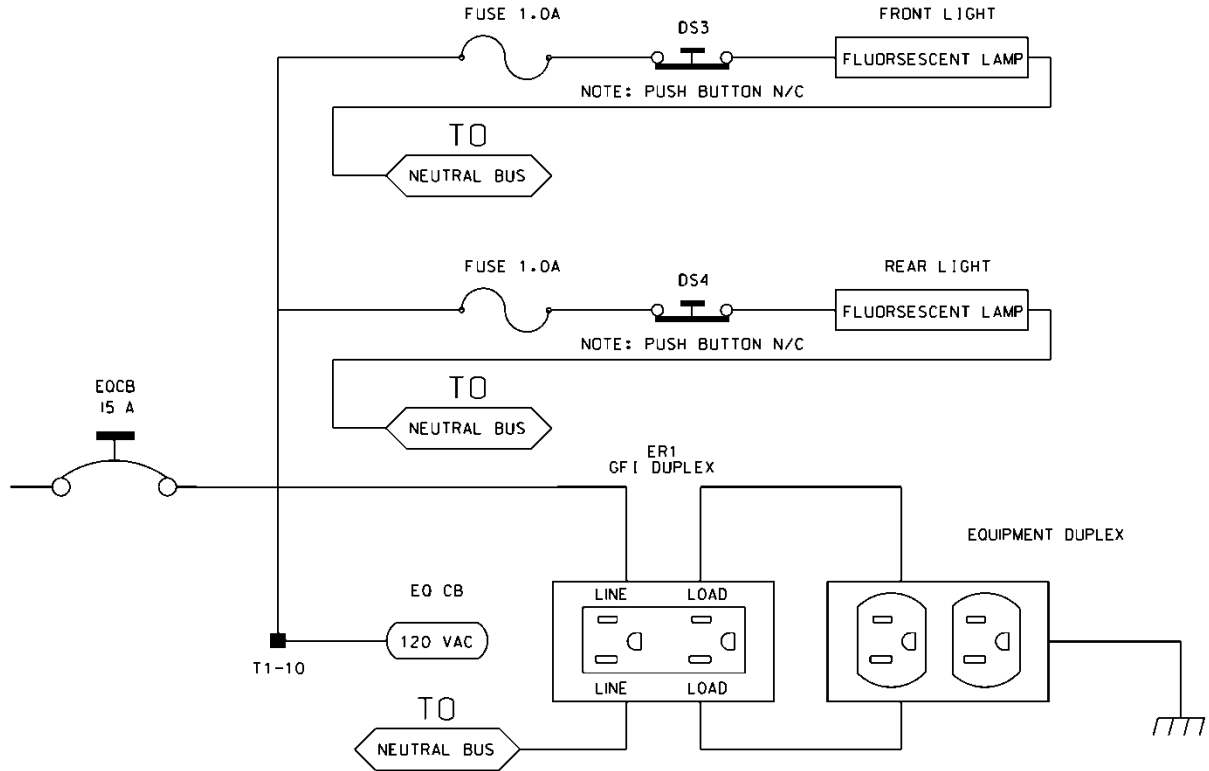

Furnish a police panel with a police panel door. For model 336S cabinets, mount the police panel on the rear door. Ensure that the police panel door permits access to the police panel when the main door is closed. Ensure that no rainwater can enter the cabinet even with the police panel door open. Provide a police panel door hinged on the right side as viewed from the front. Provide a police panel door lock that is keyed to a standard police/fire call box key. In addition to the requirements of LA Specification No. 54-053-08, provide the police panel with a toggle switch connected to switch the intersection operation between normal stop-and-go operation (AUTO) and manual operation (MANUAL). Ensure that manual control can be implemented using inputs and software such that the controller provides full programmed clearance times for the yellow clearance and red clearance for each phase while under manual control.

Provide a 1/4-inch locking phone jack in the police panel for a hand control to manually control the intersection. Provide sufficient room in the police panel for storage of a hand control and cord.

Ensure the 336S cabinet Input File is wired as follows:

336S Cabinet														
Port-Bit/C-1 Pin Assignment														
Slot #	1	2	3	4	5	6	7	8	9	10	11	12	13	14
C-1 (Spares)	59	60	61	62	63	64	65	66	75	76	77	78	79	80
Port	3-2	1-1	3-4	1-3	3-1	1-2	3-3	1-4	2-5	5-5	5-6	5-1	5-2	6-7
C-1	56	39	58	41	55	40	57	42	51	71	72	67	68	81
Port	2-1	1-5	2-3	1-7	2-2	1-6	2-4	1-8	2-6	5-7	5-8	5-3	5-4	6-8
C-1	47	43	49	45	48	44	50	46	52	73	74	69	70	82

For model 332 base mounted cabinets, ensure terminals J14-E and J14-K are wired together on the rear of the Input File. Connect TB9-12 (J14 Common) on the Input Panel to T1-2 (AC-) on the rear of the PDA.

Provide detector test switches mounted at the top of the cabinet rack or other convenient location which may be used to place a call on each of eight phases based on the chart below. Provide three positions for each switch: On (place call), Off (normal detector operation), and Momentary On (place momentary call and return to normal detector operation after switch is released). Ensure that the switches are located such that the technician can read the controller display and observe the intersection.

Connect detector test switches for cabinets as follows:

336S Cabinet		332 Cabinet	
Detector Call Switches	Terminals	Detector Call Switches	Terminals
Phase 1	I1-F	Phase 1	I1-W
Phase 2	I2-F	Phase 2	I4-W
Phase 3	I3-F	Phase 3	I5-W
Phase 4	I4-F	Phase 4	I8-W
Phase 5	I5-F	Phase 5	J1-W
Phase 6	I6-F	Phase 6	J4-W
Phase 7	I7-F	Phase 7	J5-W
Phase 8	I8-F	Phase 8	J8-W

Provide the PCB 28/56 connector for the conflict monitor unit (CMU) with 28 independent contacts per side, dual-sided with 0.156 inch contact centers. Provide the PCB 28/56 connector contacts with solder eyelet terminations. Ensure all connections to the PCB 28/56 connector are soldered to the solder eyelet terminations.

Ensure that all cabinets have the CMU connector wired according to the 332 cabinet connector pin assignments (include all wires for auxiliary output file connection). Wire pins 13, 16, R, and U of the CMU connector to a separate 4 pin plug, P1, as shown below. Provide a second plug, P2, which will mate with P1 and is wired to the auxiliary output file as shown below. Provide an additional plug, P3, which will mate with P1 and is wired to the pedestrian yellow circuits as shown

below. When no auxiliary output file is installed in the cabinet, provide wires for the green and yellow inputs for channels 11, 12, 17, and 18, the red inputs for channels 17 and 18, and the wires for the P2 plug. Terminate the two-foot wires with ring type lugs, insulated, and bundled for optional use.

PIN	P1		P2		P3	
	FUNCTION	CONN TO	FUNCTION	CONN TO	FUNCTION	CONN TO
1	CH-9G	CMU-13	OLA-GRN	A123	2P-YEL	114
2	CH-9Y	CMU-16	OLA-YEL	A122	4P-YEL	105
3	CH-10G	CMU-R	OLB-GRN	A126	6P-YEL	120
4	CH-10Y	CMU-U	OLB-YEL	A125	8P-YEL	111

Do not provide the P20 terminal assembly (red monitor board) or red interface ribbon cable as specified in LA Specification No. 54-053-08.

Provide a P20 connector that mates with and is compatible with the red interface connector mounted on the front of the conflict monitor. Ensure that the P20 connector and the red interface connector on the conflict monitor are center polarized to ensure proper connection. Ensure that removal of the P20 connector will cause the conflict monitor to recognize a latching fault condition and place the cabinet into flashing operation.

Wire the P20 connector to the output file and auxiliary output file using 22 AWG stranded wires. Ensure the length of these wires is a minimum of 42 inches in length. Provide a durable braided sleeve around the wires to organize and protect the wires.

Wire the P20 connector to the traffic signal red displays to provide inputs to the conflict monitor as shown below. Ensure the pedestrian Don't Walk circuits are wired to channels 13 through 16 of the P20 connector. When no auxiliary output file is installed in the cabinet, provide wires for channels 9 through 12 reds. Provide a wire for special function 1. Terminate the unused wires with ring type lugs, insulated, and bundled for optional use.

P20 Connector					
PIN	FUNCTION	CONN TO	PIN	FUNCTION	CONN TO
1	Channel 15 Red	119	2	Channel 16 Red	110
3	Channel 14 Red	104	4	Chassis GND	01-9
5	Channel 13 Red	113	6	N/C	
7	Channel 12 Red	AUX 101	8	Spec Function 1	
9	Channel 10 Red	AUX 124	10	Channel 11 Red	AUX 114
11	Channel 9 Red	AUX 121	12	Channel 8 Red	107
13	Channel 7 Red	122	14	Channel 6 Red	134
15	Channel 5 Red	131	16	Channel 4 Red	101
17	Channel 3 Red	116	18	Channel 2 Red	128
19	Channel 1 Red	125	20	Red Enable	01-14



Ensure the controller unit outputs to the auxiliary output file are pre-wired to the C5 connector. When no auxiliary output file is installed in the cabinet, connect the C5 connector to a storage socket located on the Input Panel or on the rear of the PDA.

Do not wire pin 12 of the load switch sockets.

In addition to the requirements of LA Specification No. 54-053-08, ensure relay K1 on the Power Distribution Assembly (PDA) is a four pole relay and K2 on the PDA is a two pole relay.

Provide a two pole, ganged circuit breaker for the flash bus circuit. Ensure the flash bus circuit breaker is an inverse time circuit breaker rated for 10 amps at 120 VAC with a minimum of 10,000 RMS symmetrical amperes short circuit current rating. Do not provide the auxiliary switch feature on the flash bus circuit breaker. Ensure the ganged flash bus circuit breaker is certified by the circuit breaker manufacturer to provide gang tripping operation.

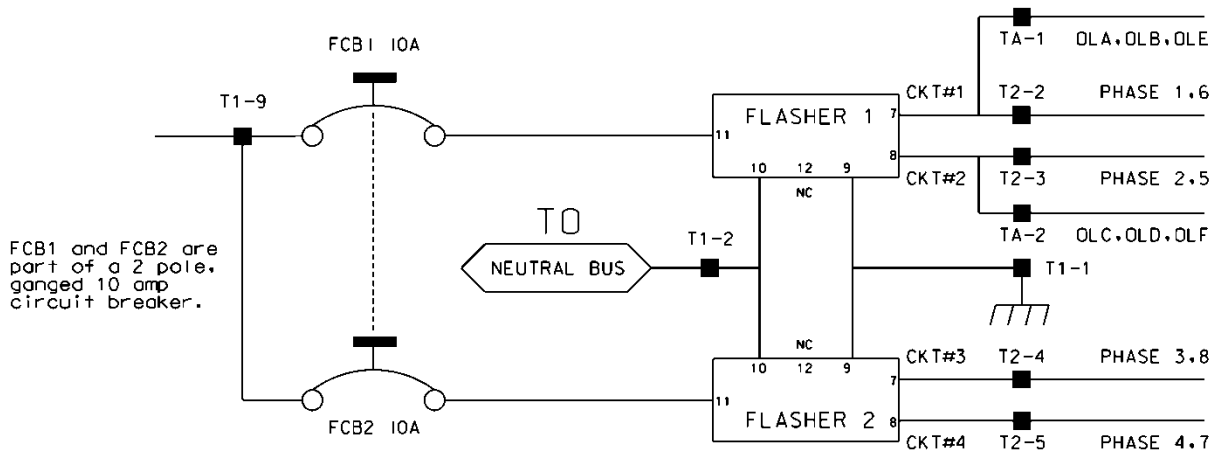

Ensure auxiliary output files are wired as follows:

AUXILIARY OUTPUT FILE TERMINAL BLOCK TA ASSIGNMENTS	
POSITION	FUNCTION
1	Flasher Unit #1, Circuit 1/FTR1 (OLA, OLB)/FTR3 (OLE)
2	Flasher Unit #1, Circuit 2/FTR2 (OLC, OLD)/FTR3 (OLF)
3	Flash Transfer Relay Coils
4	AC -
5	Power Circuit 5
6	Power Circuit 5
7	Equipment Ground Bus
8	NC

Provide four spare load resistors mounted in each cabinet. Ensure each load resistor is rated as shown in the table below. Wire one side of each load resistor to AC-. Connect the other side of each resistor to a separate terminal on a four (4) position terminal block. Mount the load resistors and terminal block either inside the back of Output File No. 1 or on the upper area of the Service Panel.

ACCEPTABLE LOAD RESISTOR VALUES	
VALUE (ohms)	WATTAGE
1.5K – 1.9 K	25W (min)
2.0K – 3.0K	10W (min)

Provide Model 200 load switches, Model 204 flashers, Model 242 DC isolators, Model 252 AC isolators, and Model 206L power supply units that conform to CALTRANS' "Transportation Electrical Equipment Specifications" dated March 12, 2009 with Erratum 1.

### C. Type 170 E Cabinet Physical Requirements:

Do not mold, cast, or scribe the name "City of Los Angeles" on the outside of the cabinet door as specified in LA Specification No. 54-053-08. Do not provide a Communications Terminal Panel as specified in LA Specification No. 54-053-08. Do not provide terminal block TBB on the Service Panel. Do not provide Cabinet Verification Test Program software or associated test jigs as specified in LA Specification No. 54-053-08.

Furnish unpainted, natural, aluminum cabinet shells. Ensure that all non-aluminum hardware on the cabinet is stainless steel or a Department approved non-corrosive alternate.

Ensure the lifting eyes, gasket channels, police panel, and all supports welded to the enclosure and doors are fabricated from 0.125 inch minimum thickness aluminum sheet and meet the same standards as the cabinet and doors.

Provide front and rear doors with latching handles that allow padlocking in the closed position. Furnish 0.75 inch minimum diameter stainless steel handles with a minimum 0.5 inch shank. Place

the padlocking attachment at 4.0 inches from the handle shank center to clear the lock and key. Provide an additional 4.0 inches minimum gripping length.

Provide Corbin #2 locks on the front and rear doors. Provide one (1) Corbin #2 and one (1) police master key with each cabinet. Ensure main door locks allow removal of keys in the locked position only.

Provide a surge protection panel with 16 loop surge protection devices and designed to allow sufficient free space for wire connection/disconnection and surge protection device replacement. For model 332 cabinets, provide an additional 20 loop surge protection devices. Provide an additional two AC+ interconnect surge devices to protect one slot and eight DC surge protection devices to protect four slots. Provide no protection devices on slot I14.

For pole mounted cabinets, mount surge protection devices for the AC+ interconnect inputs, inductive loop detector inputs, and low voltage DC inputs on a swing down panel assembly fabricated from sturdy aluminum. Attach the swing down panel to the bottom rear cabinet rack assembly using thumb screws. Ensure the swing down panel allows for easy removal of the input file without removing the surge protection panel assembly or its parts. Have the surge protection devices mounted horizontally on the panel and soldered to the feed through terminals of four 14 position terminal blocks with #8 screws mounted on the other side. Ensure the top row of terminals is connected to the upper slots and the bottom row of terminals is connected to the bottom slots. Provide a 15 position copper equipment ground bus attached to the field terminal side (outside) of the swing down panel for termination of loop lead-in shield grounds. Ensure that a Number 4 AWG green wire connects the surge protection panel assembly ground bus to the main cabinet equipment ground.

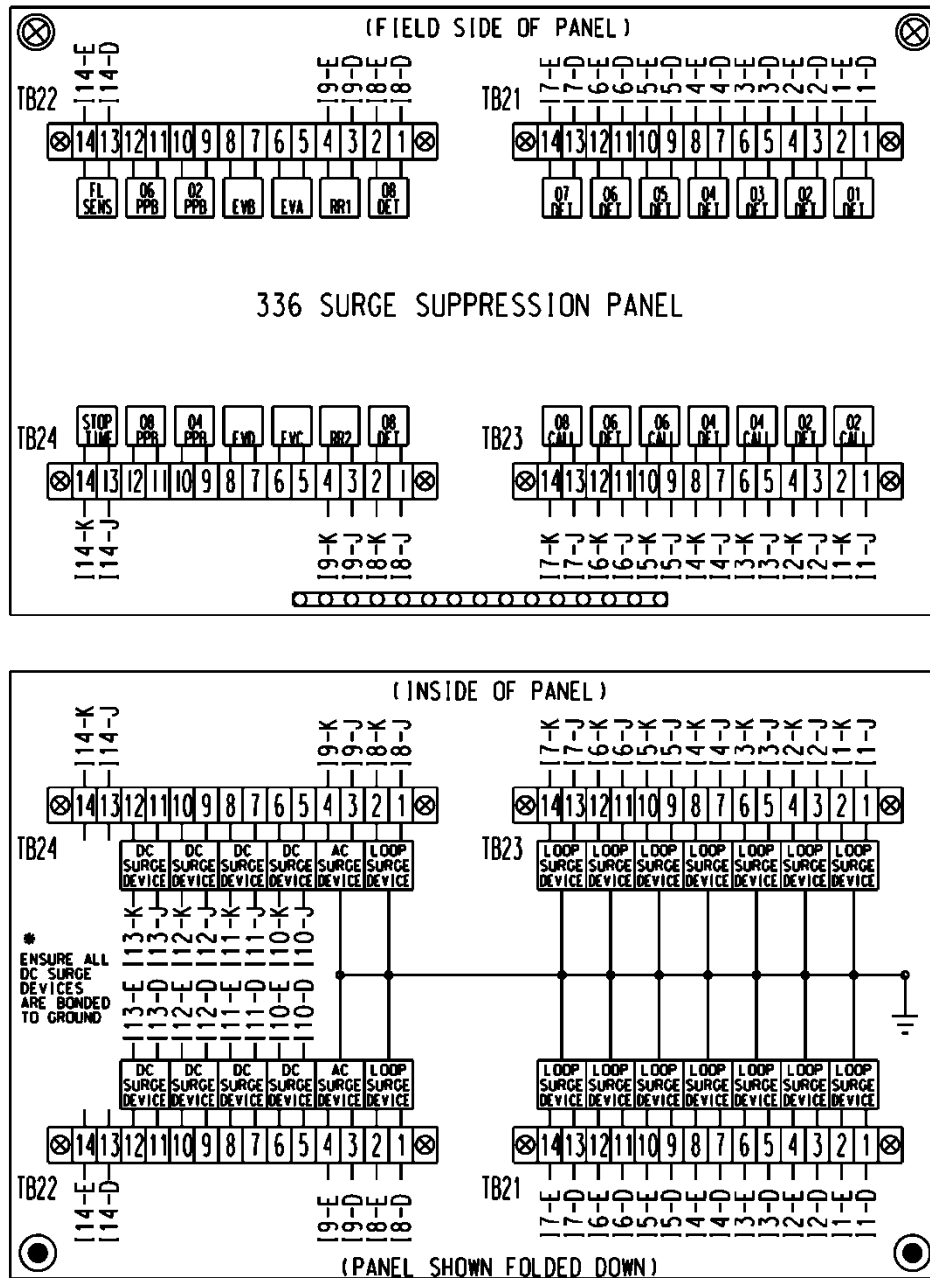

For base mounted cabinets, mount surge protection panels on the left side of the cabinet as viewed from the rear. Attach each panel to the cabinet rack assembly using bolts and make it easily removable. Mount the surge protection devices in vertical rows on each panel and connect the devices to one side of 12 position, double row terminal blocks with #8 screws. For each surge protection panel, terminate all grounds from the surge protection devices on a copper equipment ground bus attached to the surge protection panel. Wire the terminals to the rear of a standard input file using spade lugs for input file protection.

Provide permanent labels that indicate the slot and the pins connected to each terminal that may be viewed from the rear cabinet door. Label and orient terminals so that each pair of inputs is next to each other. Indicate on the labeling the input file (I or J), the slot number (1-14) and the terminal pins of the input slots (either D & E for upper or J & K for lower).

Provide a minimum 14 x 16 inch pull out, hinged top shelf located immediately below controller mounting section of the cabinet. Ensure the shelf is designed to fully expose the table surface outside the controller at a height approximately even with the bottom of the controller. Ensure the shelf has a storage bin interior which is a minimum of 1 inch deep and approximately the same dimensions as the shelf. Provide an access to the storage area by lifting the hinged top of the shelf. Fabricate the shelf and slide from aluminum or stainless steel and ensure the assembly can support the 2070L controller plus 15 pounds of additional weight. Ensure shelf has a locking mechanism to secure it in the fully extended position and does not inhibit the removal of the 2070L controller or removal of cards inside the controller when fully extended. Provide a locking mechanism that is easily released when the shelf is to be returned to its non-use position directly under the controller.

#### **D. Model 2018 Enhanced Conflict Monitor:**

Furnish Model 2018 Enhanced Conflict Monitors that provide monitoring of 18 channels. Ensure each channel consists of a green, yellow, and red field signal input. Ensure that the conflict monitor meets or exceeds CALTRANS' Transportation Electrical Equipment Specifications dated March 12, 2009, with Erratum 1 (hereafter referred to as CALTRANS' 2009 TEES) for a model 210 monitor unit and other requirements stated in this specification.

Ensure the conflict monitor is provided with an 18 channel conflict programming card. Pin EE and Pin T of the conflict programming card shall be connected together. Pin 16 of the conflict programming card shall be floating. Ensure that the absence of the conflict programming card will cause the conflict monitor to trigger (enter into fault mode), and remain in the triggered state until the programming card is properly inserted and the conflict monitor is reset.

Provide a conflict monitor that incorporates LED indicators into the front panel to dynamically display the status of the monitor under normal conditions and to provide a comprehensive review of field inputs with monitor status under fault conditions. Ensure that the monitor indicates the channels that were active during a conflict condition and the channels that experienced a failure for all other per channel fault conditions detected. Ensure that these indications and the status of each channel are retained until the Conflict Monitor is reset. Furnish LED indicators for the following:

- AC Power (Green LED indicator)
- VDC Failed (Red LED indicator)
- WDT Error (Red LED indicator)
- Conflict (Red LED indicator)
- Red Fail (Red LED indicator)
- Dual Indication (Red LED indicator)
- Yellow/Clearance Failure (Red LED indicator)
- PCA/PC Ajar (Red LED indicator)
- Monitor Fail/Diagnostic Failure (Red LED indicator)
- 54 Channel Status Indicators (1 Red, 1 Yellow, and 1 Green LED indicator for each of the 18 channels)

Provide a switch to set the Red Fail fault timing. Ensure that when the switch is in the ON position the Red Fail fault timing value is set to 1350 +/- 150 ms (2018 mode). Ensure that when the switch is in the OFF position the Red Fail fault timing value is set to 850 +/- 150 ms (210 mode).

Provide a switch to set the Watchdog fault timing. Ensure that when the switch is in the ON position the Watchdog fault timing value is set to 1.0 +/- 0.1 s (2018 mode). Ensure that when the switch is in the OFF position the Watchdog fault timing value is set to 1.5 +/- 0.1 s (210 mode).

Provide a jumper or switch to set the AC line brown-out levels. Ensure that when the jumper is present or the switch is in the ON position the AC line dropout voltage threshold is 98 +/- 2 Vrms, the AC line restore voltage threshold is 103 +/- 2 Vrms, and the AC line brown-out timing value is set to 400 +/- 50ms (2018 mode). Ensure that when the jumper is not present or the switch is in the OFF position the AC line dropout voltage threshold is 92 +/- 2 Vrms, the AC line restore voltage threshold is 98 +/- 2 Vrms, and the AC line brown-out timing value is set to 80 +/- 17 ms (210 mode).

Provide a jumper or switch that will enable and disable the Watchdog Latch function. Ensure that when the jumper is not present or the switch is in the OFF position the Watchdog Latch function is disabled. In this mode of operation, a Watchdog fault will be reset following a power loss, brownout, or power interruption. Ensure that when the jumper is present or the switch is in the ON position the Watchdog Latch function is enabled. In this mode of operation, a Watchdog fault will be retained until a Reset command is issued.

Provide a jumper that will reverse the active polarity for pin #EE (output relay common). Ensure that when the jumper is not present pin #EE (output relay common) will be considered 'Active' at a voltage greater than 70 Vrms and 'Not Active' at a voltage less than 50 Vrms (Caltrans mode). Ensure that when the jumper is present pin #EE (output relay common) will be considered 'Active' at a voltage less than 50 Vrms and 'Not Active' at a voltage greater than 70 Vrms (Failsafe mode).

In addition to the connectors required by CALTRANS' 2009 TEES, provide the conflict monitor with a red interface connector mounted on the front of the monitor. Ensure the connector is a 20 pin, right angle, center polarized, male connector with latching clip locks and polarizing keys. Ensure the right angle solder tails are designed for a 0.062" thick printed circuit board. Keying of the connector shall be between pins 3 and 5, and between 17 and 19. Ensure the connector has two rows of pins with the odd numbered pins on one row and the even pins on the other row. Ensure the connector pin row spacing is 0.10" and pitch is 0.10". Ensure the mating length of the connector pins is 0.24". Ensure the pins are finished with gold plating 30μ" thick.

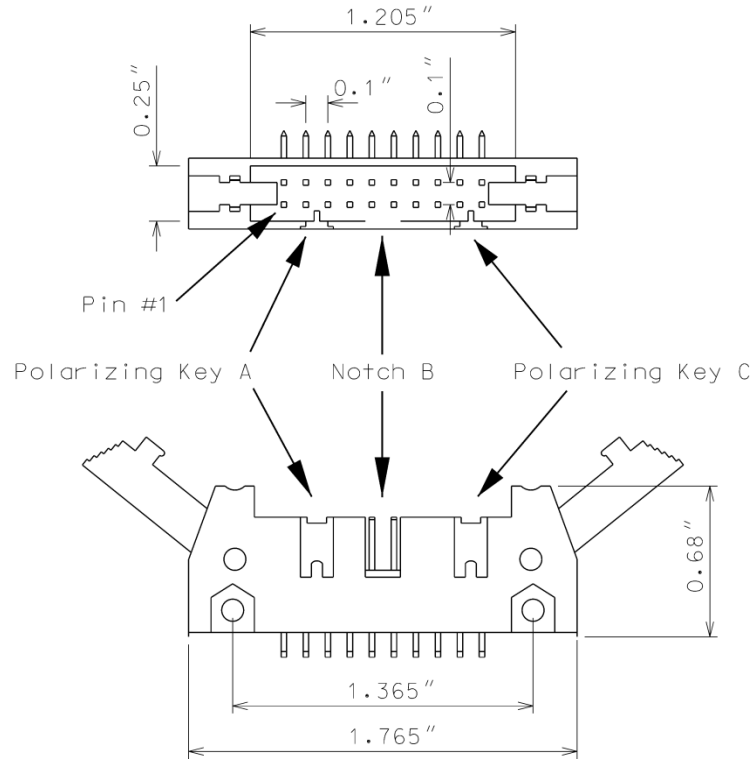

Ensure the red interface connector pins on the monitor have the following functions:

Pin #	Function	Pin #	Function
1	Channel 15 Red	2	Channel 16 Red
3	Channel 14 Red	4	Chassis Ground
5	Channel 13 Red	6	Special Function 2
7	Channel 12 Red	8	Special Function 1
9	Channel 10 Red	10	Channel 11 Red
11	Channel 9 Red	12	Channel 8 Red
13	Channel 7 Red	14	Channel 6 Red
15	Channel 5 Red	16	Channel 4 Red
17	Channel 3 Red	18	Channel 2 Red
19	Channel 1 Red	20	Red Enable

Ensure that removal of the P20 cable connector will cause the conflict monitor to recognize a latching fault condition and place the cabinet into flashing operation.

Provide Special Function 1 and Special Function 2 inputs to the unit which shall disable only Red Fail Monitoring when either input is sensed active. A Special Function input shall be sensed active when the input voltage exceeds 70 Vrms with a minimum duration of 550 ms. A Special Function input shall be sensed not active when the input voltage is less than 50 Vrms or the duration is less

than 250 ms. A Special Function input is undefined by these specifications and may or may not be sensed active when the input voltage is between 50 Vrms and 70 Vrms or the duration is between 250 ms and 550 ms.

Ensure the conflict monitor recognizes field signal inputs for each channel that meet the following requirements:

- consider a Red input greater than 70 Vrms and with a duration of at least 500 ms as an “on” condition;
- consider a Red input less than 50 Vrms or with a duration of less than 200 ms as an “off” condition (no valid signal);
- consider a Red input between 50 Vrms and 70 Vrms or with a duration between 200 ms and 500 ms to be undefined by these specifications;
- consider a Green or Yellow input greater than 25 Vrms and with a duration of at least 500 ms as an “on” condition;
- consider a Green or Yellow input less than 15 Vrms or with a duration of less than 200 ms as an “off” condition; and
- consider a Green or Yellow input between 15 Vrms and 25 Vrms or with a duration between 200 ms and 500 ms to be undefined by these specifications.

Provide a conflict monitor that recognizes the faults specified by CALTRANS’ 2009 TEES and the following additional faults. Ensure the conflict monitor will trigger upon detection of a fault and will remain in the triggered (in fault mode) state until the unit is reset at the front panel or through the external remote reset input for the following failures:

1. **Red Monitoring or Absence of Any Indication (Red Failure):** A condition in which no “on” voltage signal is detected on any of the green, yellow, or red inputs to a given monitor channel. If a signal is not detected on at least one input (R, Y, or G) of a conflict monitor channel for a period greater than 1000 ms when used with a 170 controller and 1500 ms when used with a 2070 controller, ensure monitor will trigger and put the intersection into flash. If the absence of any indication condition lasts less than 700 ms when used with a 170 controller and 1200 ms when used with a 2070 controller, ensure conflict monitor will not trigger. Red fail monitoring shall be enabled on a per channel basis by the use of switches located on the conflict monitor. Have red monitoring occur when all of the following input conditions are in effect:
  - a) Red Enable input to monitor is active (Red Enable voltages are “on” at greater than 70 Vrms, off at less than 50 Vrms, undefined between 50 and 70 Vrms), and
  - b) Neither Special Function 1 nor Special Function 2 inputs are active.
  - c) Pin #EE (output relay common) is not active
2. **Short/Missing Yellow Indication Fault (Clearance Error):** Yellow indication following a green is missing or shorter than 2.7 seconds (with  $\pm 0.1$ -second accuracy). If a channel fails to detect an “on” signal at the Yellow input for a minimum of 2.7 seconds ( $\pm 0.1$  second) following the detection of an “on” signal at a Green input for that channel, ensure that the monitor triggers and generates a clearance/short yellow error fault indication. Short/missing



yellow (clearance) monitoring shall be enabled on a per channel basis by the use of switches located on the conflict monitor. This fault shall not occur when the channel is programmed for Yellow Inhibit, when the Red Enable signal is inactive or pin #EE (output relay common) is active.

3. **Dual Indications on the Same Channel:** In this condition, more than one indication (R,Y,G) is detected as “on” at the same time on the same channel. If dual indications are detected for a period greater than 500 ms, ensure that the conflict monitor triggers and displays the proper failure indication (Dual Ind fault). If this condition is detected for less than 200 ms, ensure that the monitor does not trigger. G-Y-R dual indication monitoring shall be enabled on a per channel basis by the use of switches located on the conflict monitor. G-Y dual indication monitoring shall be enabled for all channels by use of a switch located on the conflict monitor. This fault shall not occur when the Red Enable signal is inactive or pin #EE (output relay common) is active.
4. **Configuration Settings Change:** The configuration settings are comprised of (as a minimum) the permissive diode matrix, dual indication switches, yellow disable jumpers, any option switches, any option jumpers, and the Watchdog Enable switch. Ensure the conflict monitor compares the current configuration settings with the previous stored configuration settings on power-up, on reset, and periodically during operation. If any of the configuration settings are changed, ensure that the conflict monitor triggers and causes the program card indicator to flash. Ensure that configuration change faults are only reset by depressing and holding the front panel reset button for a minimum of three seconds. Ensure the external remote reset input does not reset configuration change faults.

Ensure the conflict monitor will trigger and the AC Power indicator will flash at a rate of  $2 \text{ Hz} \pm 20\%$  with a 50% duty cycle when the AC Line voltage falls below the “drop-out” level. Ensure the conflict monitor will resume normal operation when the AC Line voltage returns above the “restore” level. Ensure the AC Power indicator will remain illuminated when the AC voltage returns above the “restore” level. Should an AC Line power interruption occur while the monitor is in the fault mode, then upon restoration of AC Line power, the monitor will remain in the fault mode and the correct fault and channel indicators will be displayed.

Provide a flash interval of at least 6 seconds and at most 10 seconds in duration following a power-up, an AC Line interruption, or a brownout restore. Ensure the conflict monitor will suspend all fault monitoring functions, close the Output relay contacts, and flash the AC indicator at a rate of  $4 \text{ Hz} \pm 20\%$  with a 50% duty cycle during this interval. Ensure the termination of the flash interval after at least 6 seconds if the Watchdog input has made 5 transitions between the True and False state and the AC Line voltage is greater than the “restore” level. If the watchdog input has not made 5 transitions between the True and False state within  $10 \pm 0.5$  seconds, the monitor shall enter a WDT error fault condition.

Ensure the conflict monitor will monitor an intersection with a minimum of four approaches using the four-section Flashing Yellow Arrow (FYA) vehicle traffic signal as outlined by the NCHRP 3-54 research project for protected-permissive left turn signal displays. Ensure the conflict monitor will operate in the FYA mode and FYAc (Compact) mode as specified below to monitor each channel pair for the following fault conditions: Conflict, Flash Rate Detection, Red Fail, Dual Indication, and

Clearance. Provide a switch to select between the FYA mode and FYAc mode. Provide a switch to select each FYA phase movement for monitoring.

**FYA mode**

FYA Signal Head	Phase 1	Phase 3	Phase 5	Phase 7
Red Arrow	Channel 9 Red	Channel 10 Red	Channel 11 Red	Channel 12 Red
Yellow Arrow	Channel 9 Yellow	Channel 10 Yellow	Channel 11 Yellow	Channel 12 Yellow
Flashing Yellow Arrow	Channel 9 Green	Channel 10 Green	Channel 11 Green	Channel 12 Green
Green Arrow	Channel 1 Green	Channel 3 Green	Channel 5 Green	Channel 7 Green

**FYAc mode**

FYA Signal Head	Phase 1	Phase 3	Phase 5	Phase 7
Red Arrow	Channel 1 Red	Channel 3 Red	Channel 5 Red	Channel 7 Red
Yellow Arrow	Channel 1 Yellow	Channel 3 Yellow	Channel 5 Yellow	Channel 7 Yellow
Flashing Yellow Arrow	Channel 1 Green	Channel 3 Green	Channel 5 Green	Channel 7 Green
Green Arrow	Channel 9 Green	Channel 9 Yellow	Channel 10 Green	Channel 10 Yellow

If a FYA channel pair is enabled for FYA operation, the conflict monitor will monitor the FYA logical channel pair for the additional following conditions:

1. **Conflict:** Channel conflicts are detected based on the permissive programming jumpers on the program card. This operation remains unchanged from normal operation except for the solid Yellow arrow (FYA clearance) signal.
2. **Yellow Change Interval Conflict:** During the Yellow change interval of the Permissive Turn channel (flashing Yellow arrow) the conflict monitor shall verify that no conflicting channels to the solid Yellow arrow channel (clearance) are active. These conflicting channels shall be determined by the program card compatibility programming of the Permissive Turn channel (flashing Yellow arrow). During the Yellow change interval of the Protected Turn channel (solid Green arrow) the conflict monitor shall verify that no conflicting channels to the solid Yellow arrow channel (clearance) are active as determined by the program card compatibility programming of the Protected Turn channel (solid Green arrow).

3. **Flash Rate Detection:** The conflict monitor unit shall monitor for the absence of a valid flash rate for the Permissive turn channel (flashing Yellow arrow). If the Permissive turn channel (flashing Yellow arrow) is active for a period greater than 1600 milliseconds, ensure the conflict monitor triggers and puts the intersection into flash. If the Permissive turn channel (flashing Yellow arrow) is active for a period less than 1400 milliseconds, ensure the conflict monitor does not trigger. Ensure the conflict monitor will remain in the triggered (in fault mode) state until the unit is reset at the front panel or through the external remote reset input. Provide a jumper or switch that will enable and disable the Flash Rate Detection function. Ensure that when the jumper is not present or the switch is in the OFF position the Flash Rate Detection function is enabled. Ensure that when the jumper is present or the switch is in the ON position the Flash Rate Detection function is disabled.
4. **Red Monitoring or Absence of Any Indication (Red Failure):** The conflict monitor unit shall detect a red failure if there is an absence of voltage on all four of the inputs of a FYA channel pair (RA, YA, FYA, GA).
5. **Dual Indications on the Same Channel:** The conflict monitor unit shall detect a dual indication if two or more inputs of a FYA channel pair (RA, YA, FYA, GA) are “on” at the same time.
6. **Short/Missing Yellow Indication Fault (Clearance Error):** The conflict monitor unit shall monitor the solid Yellow arrow for a clearance fault when terminating both the Protected Turn channel (solid Green arrow) interval and the Permissive Turn channel (flashing Yellow arrow) interval.

Ensure that the conflict monitor will log at least nine of the most recent events detected by the monitor in non-volatile EEPROM memory (or equivalent). For each event, record at a minimum the time, date, type of event, status of each field signal indication with RMS voltage, and specific channels involved with the event. Ensure the conflict monitor will log the following events: monitor reset, configuration, previous fault, and AC line. Furnish the signal sequence log that shows all channel states (Greens, Yellows, and Reds) and the Red Enable State for a minimum of 2 seconds prior to the current fault trigger point. Ensure the display resolution of the inputs for the signal sequence log is not greater than 50 ms.

For conflict monitors used within an Ethernet communications system, provide a conflict monitor with an Ethernet 10/100 Mbps, RJ-45 port for data communication access to the monitor by a local notebook computer and remotely via a workstation or notebook computer device connected to the signal system local area network. The Ethernet port shall be electrically isolated from the conflict monitor’s electronics and shall provide a minimum of 1500 Vrms isolation. Integrate monitor with Ethernet network in cabinet. Provide software to retrieve the time and date from a network server in order to synchronize the on-board times between the conflict monitor and the controller. Furnish and install the following Windows based, graphic user interface software on workstations and notebook computers where the signal system client software is installed: 1) software to view and retrieve all event log information, 2) software that will search and display a list of conflict monitor IP addresses and IDs on the network, and 3) software to change the conflict monitor’s network parameters such as IP address and subnet mask.

For non-Ethernet connected monitors, provide a RS-232C/D compliant port (DB-9 female connector) on the front panel of the conflict monitor in order to provide communications from the conflict monitor to the 170/2070 controller or to a Department-furnished laptop computer. Electrically isolate the port interface electronics from all monitor electronics, excluding Chassis Ground. Ensure that the controller can receive all event log information through a controller

Asynchronous Communications Interface Adapter (Type 170E) or Async Serial Comm Module (2070). Furnish and connect a serial cable from the conflict monitor's DB-9 connector to Comm Port 1 of the 2070 controller. Ensure conflict monitor communicates with the controller. Provide a Windows based graphic user interface software to communicate directly through the same monitor RS-232C/D compliant port to retrieve and view all event log information to a Department-furnished laptop computer. The RS-232C/D compliant port on the monitor shall allow the monitor to function as a DCE device with pin connections as follows:

<b>Conflict Monitor RS-232C/D (DB-9 Female) Pinout</b>		
<b>Pin Number</b>	<b>Function</b>	<b>I/O</b>
1	DCD	O
2	TX Data	O
3	RX Data	I
4	DTR	I
5	Ground	-
6	DSR	O
7	CTS	I
8	RTS	O
9	NC	-

---

**MONITOR BOARD EDGE CONNECTOR**

---

<b>Pin #</b>	<b>Function (Back Side)</b>	<b>Pin #</b>	<b>Function (Component Side)</b>
1	Channel 2 Green	A	Channel 2 Yellow
2	Channel 13 Green	B	Channel 6 Green
3	Channel 6 Yellow	C	Channel 15 Green
4	Channel 4 Green	D	Channel 4 Yellow
5	Channel 14 Green	E	Channel 8 Green
6	Channel 8 Yellow	F	Channel 16 Green
7	Channel 5 Green	H	Channel 5 Yellow
8	Channel 13 Yellow	J	Channel 1 Green
9	Channel 1 Yellow	K	Channel 15 Yellow
10	Channel 7 Green	L	Channel 7 Yellow
11	Channel 14 Yellow	M	Channel 3 Green
12	Channel 3 Yellow	N	Channel 16 Yellow
13	Channel 9 Green	P	Channel 17 Yellow
14	Channel 17 Green	R	Channel 10 Green
15	Channel 11 Yellow	S	Channel 11 Green
16	Channel 9 Yellow	T	Channel 18 Yellow
17	Channel 18 Green	U	Channel 10 Yellow
--		--	
18	Channel 12 Yellow	V	Channel 12 Green
19	Channel 17 Red	W	Channel 18 Red
20	Chassis Ground	X	Not Assigned
21	AC-	Y	DC Common
22	Watchdog Timer	Z	External Test Reset
23	+24VDC	AA	+24VDC
24	Tied to Pin 25	BB	Stop Time (Output)
25	Tied to Pin 24	CC	Not Assigned
26	Not Assigned	DD	Not Assigned
27	Relay Output, Side #3, N.O.	EE	Relay Output, Side #2, Common
28	Relay Output, Side #1, N.C.	FF	AC+

-- Slotted for keying between Pins 17/U and 18/V

---

**CONFLICT PROGRAM CARD PIN ASSIGNMENTS**

---

<b>Pin #</b>	<b>Function (Back Side)</b>	<b>Pin #</b>	<b>Function (Component Side)</b>
1	Channel 2 Green	A	Channel 1 Green
2	Channel 3 Green	B	Channel 2 Green
3	Channel 4 Green	C	Channel 3 Green
4	Channel 5 Green	D	Channel 4 Green
5	Channel 6 Green	E	Channel 5 Green
6	Channel 7 Green	F	Channel 6 Green
7	Channel 8 Green	H	Channel 7 Green
8	Channel 9 Green	J	Channel 8 Green
9	Channel 10 Green	K	Channel 9 Green
10	Channel 11 Green	L	Channel 10 Green
11	Channel 12 Green	M	Channel 11 Green
12	Channel 13 Green	N	Channel 12 Green
13	Channel 14 Green	P	Channel 13 Green
14	Channel 15 Green	R	Channel 14 Green
15	Channel 16 Green	S	Channel 15 Green
16	N/C	T	PC AJAR
17	Channel 1 Yellow	U	Channel 9 Yellow
18	Channel 2 Yellow	V	Channel 10 Yellow
19	Channel 3 Yellow	W	Channel 11 Yellow
20	Channel 4 Yellow	X	Channel 12 Yellow
21	Channel 5 Yellow	Y	Channel 13 Yellow
22	Channel 6 Yellow	Z	Channel 14 Yellow
23	Channel 7 Yellow	AA	Channel 15 Yellow
24	Channel 8 Yellow	BB	Channel 16 Yellow
--		--	
25	Channel 17 Green	CC	Channel 17 Yellow
26	Channel 18 Green	DD	Channel 18 Yellow
27	Channel 16 Green	EE	PC AJAR (Program Card)
28	Yellow Inhibit Common	FF	Channel 17 Green

-- Slotted for keying between Pins 24/BB and 25/CC

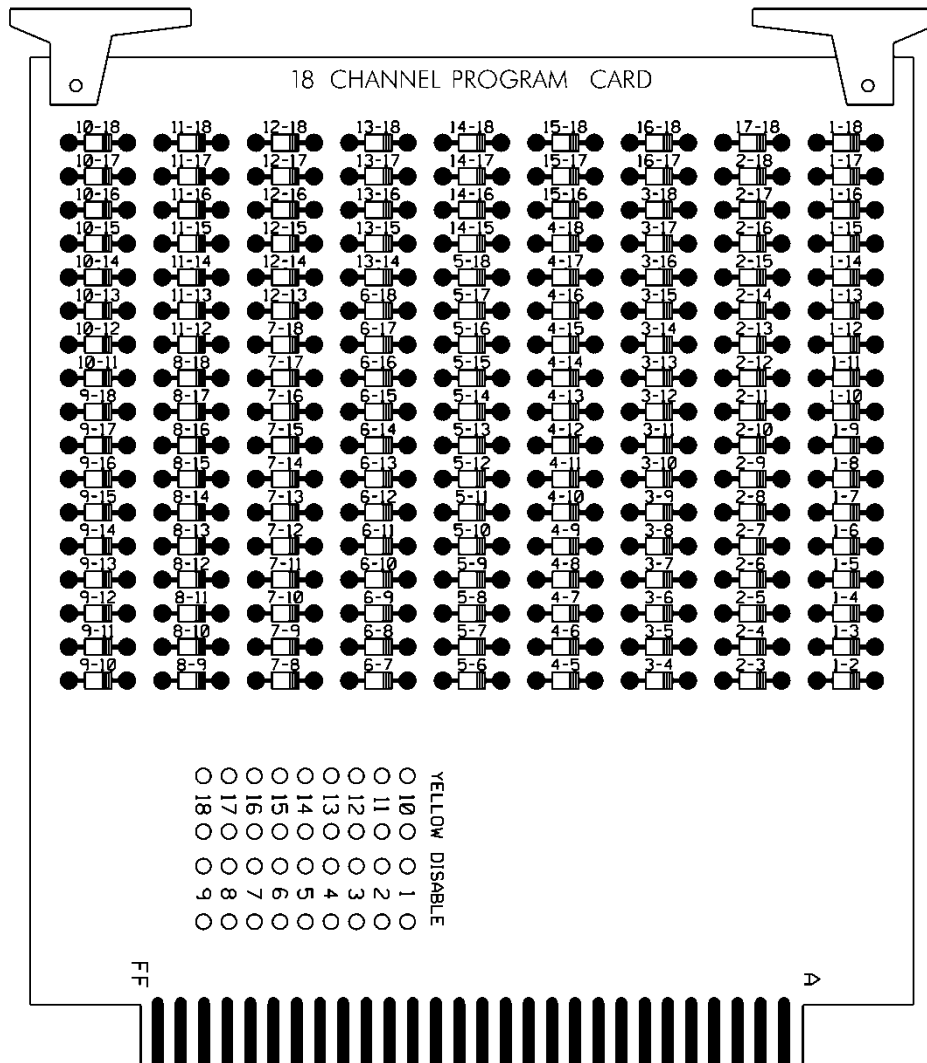

**3.4. MATERIALS – TYPE 170 DETECTOR SENSOR UNITS**

Furnish detector sensor units that comply with Chapter 5 Section 1, “General Requirements,” and Chapter 5 Section 2, “Model 222 & 224 Loop Detector Sensor Unit Requirements,” of the CALTRANS “Transportation Electrical Equipment Specifications” dated March 12, 2009 with Erratum 1.

**3.5. MATERIALS – TYPE 2070E CONTROLLERS**

Furnish model 2070E controller units that conform to CALTRANS *Transportation Electrical Equipment Specifications* (TEES) (dated March 12, 2009, plus Errata 1 dated January 21, 2010 and Errata 2 dated December 5, 2014) except as required herein.

The Department will provide software at the beginning of the burning-in period. Contractor shall give 5 working days notice before needing software. Program software provided by the Department.

Provide model 2070E controllers with OS-9 release 1.3.1 or later with kernel edition #380 or later operating software and device drivers, composed of the unit chassis and at a minimum the following modules and assemblies:

- MODEL 2070-1E, CPU Module, Single Board, with 8Mb Datakey (blue in color)

- MODEL 2070-2E+, Field I/O Module (FI/O)
  - Note: Configure the Field I/O Module to disable both the External WDT Shunt/Toggle Switch and SP3 (SP3 active indicator is “off”)
- MODEL 2070-3B, Front Panel Module (FP), Display B (8x40)
- MODEL 2070-4A, Power Supply Module, 10 AMP
- MODEL 2070-7A, Async Serial Com Module (9-pin RS-232)

#### **4. MICROWAVE VEHICLE DETECTION SYSTEM - MULTIPLE DETECTION ZONES**

##### **4.1. DESCRIPTION**

Design, furnish and install a microwave vehicle detection system with the manufacturer recommended cables and hardware in accordance to the plans and specifications. Ensure the detection system provides multiple detection zones.

##### **4.2. MATERIALS**

Provide design drawings showing design details and microwave sensor locations for review and acceptance before installation. Provide mounting height and location requirements for microwave sensor units on the design based on a site survey. Design microwave vehicle detection system with all necessary hardware. Indicate all necessary poles, spans, mast arms, luminaire arms, cables, microwave sensor mounting assemblies and hardware to achieve the required detection zones where Department owned poles are not adequate to locate the microwave sensor units. Do not design for the installation of poles in medians.

Obtain the Engineer’s approval before furnishing microwave vehicle detection system. The contractor is responsible for the final design of microwave vehicle detection system. Review and acceptance of the designs by the Department does not relieve the contractor from the responsibility to provide fully functional systems and to ensure that the required detection zones can be provided. With the exception of contractor-furnished poles, mast arms, and luminaire arms, furnish material, equipment, and hardware under this section that is pre-approved on the ITS and Signals QPL. Submit and obtain Engineer’s approval of shop drawings for any poles, mast arms, and luminaire arms provided by the contractor prior to ordering from manufacturer.

Provide a detector for either side-fire or forward-fire configuration. Ensure the detector will detect vehicles in sunny, cloudy, rainy, snowy, and foggy weather conditions. Ensure the detector can operate from the voltage supplied by a NEMA TS-1/TS-2 or Type 332 or 336 traffic signal cabinet. Ensure the detector can provide detection calls to the traffic signal controller within a NEMA TS-1/TS-2 or Type 332 or 336 cabinet. Ensure the detection system provides a constant call in the event of a component failure or loss of power. Ensure the detector has an operating temperature range of -30 to 165 degrees F and operates within the frequency range of 10 to 25 GHz. Ensure the detector is provided with a water-tight housing offering NEMA 4X protection and operates properly in up to 95% relative humidity, non-condensing.

Provide each detector unit to allow the placement of at least 8 detection zones with a minimum of 8 detection channel outputs. When the microwave vehicle detection system requires an integrated card rack interface(s), provide only enough interface cards to implement the vehicle detection shown on the signal plans. Provide a means acceptable to the Engineer to configure traffic lanes and detection zones. Provide each channel output with a programmable means to delay the output call upon activation of a detection zone that is adjustable in one second increments (maximum) over the range of 0 to 25 seconds. Provide each channel output with a programmable means to extend the



output call that is adjustable in one second increments (maximum) over the range of 0 to 25 seconds. Ensure both delay and extend timing can be set for the same channel output.

For advance detection system, ensure the detector senses vehicles in motion at a range of 50 to 400 feet from the detector unit for forward-fire configuration and a range of 50 to 200 feet from the detector unit for side-fire configuration with an accuracy of 95% for both configurations. Ensure the advance detection system provides each channel output call of at least 100 ms in duration.

For stop bar presence detection system, ensure the detector outputs a constant call while a vehicle is in the detection zone and removes the call after all vehicles exit the detection zone. Ensure the presence detector unit can cover a detection zone as shown on the plans and has an effective range of 10 to 120 feet from the detector unit.

For units without an integrated card rack interface, provide Form C output relay contacts rated a minimum of 3A, 24VDC.

If a laptop is used to adjust detector settings, ensure that software is licensed for use by the Department and by any other agency responsible for maintaining or operating the microwave detection system. Provide the Department with a license to duplicate and distribute the software as necessary for design and maintenance support.

After initial detector configuration and installation, ensure routine adjustments or calibration are not needed to maintain acceptable performance.

**4.3. CONSTRUCTION METHODS**

Install the microwave vehicle detection system in accordance with the manufacturer’s recommendations.

Monitor and maintain each detector unit during construction to ensure microwave vehicle detection system is functioning properly and aimed for the detection zone shown in the plans. Refer to Subarticle 1700-3 (D) Maintenance and Repair of Materials of the *Standard Specifications* for failure to maintain the microwave detection system.

**4.4. MEASUREMENT AND PAYMENT**

Actual number of microwave vehicle detection systems – multiple zones furnished, installed, and accepted.

No measurement will be made of cables or hardware, as these will be considered incidental to furnishing and installing microwave vehicle detection systems.

Payment will be made under:

Microwave Vehicle Detection System – Multiple Zones ..... Each

**5. METAL POLE SUPPORTS**

**5.1. METAL POLES**

**A. General:**

Furnish and install metal poles, grounding systems, and all necessary hardware. Work covered under this special provision includes requirements for design, fabrication, and installation of standard and custom/site-specific designed metal pole supports and associated foundations.

Comply with applicable sections of the *2018 STANDARD SPECIFICATIONS FOR ROADS & STRUCTURES*, hereinafter referred to as the *Standard Specifications*. Provide designs of completed assemblies with hardware equaling or exceeding *AASHTO Standard Specifications for Structural*

*Supports for Highway Signs, Luminaires and Traffic Signals* 6<sup>th</sup> Edition, 2013 (hereinafter called 6<sup>th</sup> Edition AASHTO), including the latest interim specifications. Provide assemblies with a round or near-round (18 sides or more) cross-section, or a multi-sided cross section with no less than six sides. The sides may be straight, convex, or concave.

For bid purposes, pole heights shown on plans are estimated from available data. Prior to furnishing metal poles, use field measurements and adjusted cross-sections to determine whether pole heights will meet required clearances. If pole heights do not meet required clearances, the Contractor should immediately notify the Engineer of the required revised pole heights.

Standard Drawings for Metal Poles are available that supplement these project special provisions. The drawings are located on the Department's website:

<https://connect.ncdot.gov/resources/safety/pages/ITS-Design-Resources.aspx>

Comply with article 1098-1B of the *Standard Specifications* for submittal requirements. Furnish shop drawings for approval. Provide copies of detailed shop drawings for each type of structure as summarized below. Ensure shop drawings include material specifications for each component. Ensure shop drawings identify welds by type and size on the detail drawing only, not in table format. **Do not release structures for fabrication until shop drawings have been approved by NCDOT.** Ensure shop drawings contain an itemized bill of materials for all structural components and associated connecting hardware.

Comply with article 1098-1A of the *Standard Specifications* for Qualified Products List (QPL) submittals. All shop drawings must include project location description, signal or asset inventory number(s) and project number or work order number.

Summary of information required for metal pole review submittal:

Item	Electronic Submittal	Comments / Special Instructions
Sealed, Approved Signal or ITS Plan/Loading Diagram	1 set	All structure design information needs to reflect the latest approved Signal or ITS plans
Custom Pole Shop Drawings	1 set	Submit drawings on 11" x 17" format media. Show NCDOT signal or asset inventory number(s), Contractor's name and relevant revision number in the title block. All drawings must have a <u>unique drawing number</u> for each project.
Standard Strain Pole Shop Drawings (from the QPL)	1 set	Submit drawings on 11" x 17" format media. Show NCDOT signal inventory number(s), Contractor's name and relevant revision number in the title block. All drawings must have a <u>unique drawing number</u> for each project.
Structure Calculations	1 set	Not required for Standard QPL Poles
Standard Strain Pole Foundation Drawings	1 set	Submit drawings on 11" x 17" format media. Submit a completed Standard Foundation Selection form for each pole using foundation table on Metal Pole Drawing M8.

Custom Foundation Drawings	1 set	Submit drawings on 11” x 17” format media. Show NCDOT signal or asset inventory number(s), Contractor’s name and relevant revision number in the title block. All drawings must have a <u>unique drawing number</u> for each project. If QPL Poles are used, include the corresponding QPL pole shop drawings with this submittal.
Foundation Calculations	1 set	<b>Submit copies of LPILE input, output, and pile tip deflection graph per Section titled Drilled Pier Foundations for Metal Poles of this specification for each foundation.</b> Not required for Standard Strain Poles (from the QPL)
Soil Boring Logs and Report	1 set	Report shall include a location plan and a soil classification report including soil capacity, water level, hammer efficiency, soil bearing pressure, soil density, etc. for each pole.

**NOTE** – All shop drawings and custom foundation design drawings must be sealed by a Professional Engineer licensed in the state of North Carolina. All geotechnical information must be sealed by either a Professional Engineer or Geologist licensed in the state of North Carolina. Include a title block and revision block on the shop drawings and foundation drawings showing the NCDOT signal or asset inventory number(s).

**Shop drawings and foundation drawings may be submitted together or separately for approval. However, shop drawings must be approved before foundations can be reviewed.** Foundation designs will be returned without review if the associated shop drawing has not been approved. Boring reports shall include the following: Engineer’s summary, boring location maps, soil classification per AASHTO Classification System, hammer efficiency, and Metal Pole Standard Foundation Selection Form. Incomplete submittals will be returned without review. The Reviewer has the right to request additional analysis and copies of the calculations to expedite the approval process.

**B. Materials:**

Fabricate metal pole from coil or plate steel that meet the requirements of ASTM A 572 Gr 55 or ASTM A 595 Grade A tubes. For structural steel shapes, plates, and bars use, as a minimum, ASTM A572 Gr 50, AASHTO M270 Gr 50, ASTM A709 Gr 50, or an approved equivalent. Provide pole shafts of round or near round (18 sides or more) cross-section, or multi-sided tubular cross-section with no less than six sides, having a uniform linear taper of 0.14 in/ft. Construct shafts from one piece of single-ply plate or coil. For anchor base fabrication, conform to the applicable bolt pattern and orientation as shown on Metal Pole Standard Drawing Sheet M2.

Use the submerged arc process, or other NCDOT previously approved process suitable for shafts, to continuously weld pole shafts along their entire length. Finish the longitudinal seam weld flush with the outside contour of the base metal. Ensure shaft has no circumferential welds except at the lower end joining the shaft to the pole base. Use full penetration groove welds with backing ring for all tube-to-transverse-plate connections in accordance with 6<sup>th</sup> Edition AASHTO. Provide welding that conforms to Article 1072-18 of the *Standard Specifications*. No field welding on any part of the pole will be permitted unless approved by a qualified Engineer.

After fabrication, hot-dip galvanize steel poles and all assembly components in accordance with section 1076-3 of the *Standard Specifications*. Design structural assemblies with weep holes large enough and properly located to drain molten zinc during the galvanization process. Galvanize hardware in accordance with section 1076-4 of the *Standard Specifications*. Ensure threaded material is brushed and retapped as necessary after galvanizing. Perform repair of damaged galvanizing in accordance with section 1076-7 of the *Standard Specifications*. Ensure all hardware is galvanized steel or stainless steel. The Contractor is responsible for ensuring the Designer/Fabricator specifies connecting hardware and/or materials that prevent a dissimilar metal corrosive reaction.

Ensure each anchor rod is 2-inch minimum diameter and 60-inch length. Provide 10-inch minimum thread projection at the top of the rod, and 8-inch minimum at the bottom of the rod. Use anchor rod assembly and drilled pier foundation materials complying with SP09\_R005, hereinafter referred to as *Foundations and Anchor Rod Assemblies for Metal Poles*.

Ensure anchor bolt hole diameters are 1/4-inch larger than the anchor bolt diameters in the base plate.

Provide a circular anchor bolt lock plate securing the anchor bolts at the embedded end with two (2) washers and two (2) nuts. Provide a base plate template matching the bolt circle diameter of the anchor bolt lock plate. Construct plates and templates from 1/4-inch minimum thick steel with a minimum width of 4 inches. Hot-dip galvanizing is not required for both plates.

Provide four (4) heavy hex nuts and four (4) flat washers for each anchor bolt. For nuts, use AASHTO M291 grade 2H, DH, or DH3 or equivalent material. For flat washers, use AASHTO M293 or equivalent material. Ensure anchor bolts have required diameters, lengths, and positions, and will develop strengths comparable to their respective poles.

For each pole, provide a grounding lug with a 1/2-inch minimum thread diameter, coarse thread stud and nut that will accommodate #4 AWG ground wire. Ensure the lug is electrically bonded to the pole and is conveniently located inside the pole at the hand hole.

Provide a removable pole cap with stainless steel attachment screws for the top of each pole. Ensure cap is cast aluminum conforming to Aluminum Association Alloy 356.0F. Furnish cap attached to the pole with a sturdy stainless-steel chain that is long enough to permit cap to hang clear of the pole-top opening when cap is removed.

Where required by the plans, furnish couplings 42 inches above bottom of the pole base for mounting of pedestrian pushbuttons. Provide mounting points consisting of 1 1/2-inch internally threaded half-couplings complying with the NEC, mounted within the poles. Ensure that couplings are essentially flush with the outside surfaces of the poles and are installed before any required hot-dip galvanizing. Provide a threaded plug in each mounting point. Ensure the surface of the plug is essentially flush with the outer end of the mounting point when installed and has a recessed slot that will accommodate a 1/2 "drive standard socket wrench.

Metal poles may be erected and fully loaded after concrete has attained a minimum allowable compressive strength of 3,000 psi.

Connect poles to grounding electrodes and bond them to the electrical service grounding electrodes.

When field drilling is necessary for wire or cable entrances into the pole, comply with the following requirements:

- Do not drill holes within 2 inches of any welds.

- Do not drill any holes larger than 3 inches in diameter without checking with the ITS & Signals Structure Engineers.
- Avoid drilling multiple holes along the same cross section of tube shafts.
- Install rubber grommets in all field drilled holes that wire, or cable will directly enter unless holes are drilled for installation of weather heads or couplings.
- Treat the inside of the drilled holes and repair all galvanized surfaces in accordance with Section 1076-7 of the latest edition of the *Standard Specification prior to installing grommets, caps, or plugs*.
- Cap or plug any existing field drilled holes that are no longer used with rubber, aluminum, or stainless-steel hole plugs.

When street lighting is installed on metal signal structures, isolate the conductors feeding the luminaires inside the pole shaft using liquid tight flexible metal conduit (Type LFMC), liquid tight flexible nonmetallic conduit (Type LFNC), high density polyethylene conduit (Type HDPE), or approved equivalent. All conductors supplying power for luminaires must run through an external disconnect prior to entrance into the structure. Comply with applicable National Electrical Safety Codes (NESC). Refer to Article "G" Luminaire Arms.

Install a ¼-inch thick plate for a concrete foundation tag to include the following information: concrete grade, depth, diameter, and reinforcement sizes of the installed foundation. Install galvanized wire mesh to cover gap between the base plate and top of foundation for debris and pest control. Refer to standard drawing M7 for further details.

Immediately notify the Engineer of any structural deficiency that becomes apparent in any assembly, or member of any assembly, because of the design requirements imposed by these specifications, the plans, or the typical drawings.

### C. Design:

Unless otherwise specified, design all metal pole support structures using the following 6<sup>th</sup> Edition AASHTO specifications:

- Design for a 50-year service life as recommended by Table 3.8.3-2.
- Use wind pressure map developed from 3-second gust speeds, as provided in Section 3.8.
- Assume wind loads as shown in Figures 3.9.4.2-2 and 3.9.4.2-3 of the 6<sup>th</sup> Edition AASHTO for Group III loading with Ice.
- Ensure metal pole support structures include natural wind gust loading and truck-induced gust loading for fatigue design, as provided in Sections 11.7.1.2 and 11.7.1.3, respectively. Designs need not consider periodic galloping forces.
- Assume 11.2 mph natural wind gust speed in North Carolina. For natural wind fatigue stress calculations, utilize a drag coefficient ( $C_d$ ) based on the yearly mean wind velocity of 11.2 mph.
- When selecting Fatigue Importance Factors, utilize Fatigue Importance Category II, as provided for in Table 11.6-1, unless otherwise specified.
- Calculate all stresses using applicable equations from Section 5. The Maximum allowable stress ratio for all metal pole support designs is 0.9.
- Conform to Sections 10.4.2 and 11.8 for deflection requirements. For CCTV and MVD support structures, ensure maximum deflection at top of pole does not exceed 2.0 percent of pole height.

- Assume the combined minimum weight of a messenger cable bundle (including messenger cable, signal cable and detector lead-in cables) is 1.3 lbs/ft. Assume the combined minimum diameter of the cable bundle is 1.3 inches.
- All CCTV and MVD poles shall meet the compact section limits per section 5.5.2 along with Table 5.5.2-1. Minimum thickness of CCTV and MVD pole shafts shall be ¼-inch.
- All CCTV and MVD poles shall use full-penetration groove weld tube-to-transverse plate connection with backing ring. Refer to Metal Pole Standard Drawing Sheet M9 for details. Fillet-welded tube-to-transverse-plate connections are not permitted.

Unless otherwise specified by special loading criteria, the following computed surface area for ice load on signal heads shall be used:

- 3-section, 12-inch, Surface area: 26.0 ft<sup>2</sup>
- 4-section, 12-inch, Surface area: 32.0 ft<sup>2</sup>
- 5-section, 12-inch, Surface area: 42.0 ft<sup>2</sup>

Design a base plate for each pole. The minimum base plate thickness for all poles is determined by the following criteria:

Case 1 Circular or rectangular solid base plate with the upright pole welded to the top surface of base plate with full penetration butt weld, where no stiffeners are provided. A base plate with a small center hole, which is less than 1/3 of the upright diameter, and located concentrically with the upright pole, may be considered as a solid base plate.

The magnitude of bending moment in the base plate, induced by the anchoring force of each anchor bolt is  $M = (P \times D_1) / 2$ , where

$M$  = bending moment at the critical section of the base plate induced by one (1) anchor bolt

$P$  = anchoring force of each anchor bolt

$D_1$  = horizontal distance between the anchor bolt center and the outer face of the upright, or the difference between the bolt circle radius and the outside radius of the upright

Locate the critical section at the face of the anchor bolt and perpendicular to the bolt circle radius. The overlapped part of two (2) adjacent critical sections is considered ineffective.

Case 2 Circular or rectangular base plate with the upright pole socketed into and attached to the base plate with two (2) lines of fillet weld, and where no stiffeners are provided, or any base plate with a center hole that is larger in diameter than 1/3 of the upright diameter.

The magnitude of bending moment induced by the anchoring force of each anchor bolt is  $M = P \times D_2$ ,

where  $P$  = anchoring force of each anchor bolt

$D_2$  = horizontal distance between the face of the upright and the face of the anchor bolt nut

Locate the critical section at the face of the anchor bolt top nut and perpendicular to the radius of the bolt circle. The overlapped part of two (2) adjacent critical sections is considered ineffective. If the base plate thickness calculated for Case 2 is less than Case 1, use the thickness calculated for Case 1.

The following additional requirements apply concerning pole base plates.

- Ensure that whichever case governs as defined above, the anchor bolt diameter is set to match the base plate thickness. If the minimum diameter required for the anchor bolt exceeds the thickness required for the base plate, set the base plate thickness equal to the required bolt diameter.
- For all metal poles, use a full penetration groove weld with a backing ring to connect the pole upright component to the base. Refer to Metal Pole Standard Drawing Sheet M3 or M4.

The Professional Engineer is wholly responsible for the design of all poles. Review and acceptance of these designs by the Department does not relieve the said Professional Engineer of his or her responsibility.

#### **D. Strain Poles:**

Refer to Metal Pole Standard Drawing Sheets M2 and M3 for fabrication details.

Provide two (2) messenger cable (span wire) clamps and associated hardware for attachment of messenger cable. Ensure diameter of the clamp is appropriate to its location on the pole and is appropriately designed for adjustment from 1'-6" below the top, down to 6'-6" below the top of the pole. Do not attach more than one (1) support cable to a messenger cable clamp.

Provide a minimum of three (3) 2-inch holes equipped with an associated coupling and weatherhead on the messenger cable load side of the pole to accommodate passage of signal cables from inside the pole. Provide galvanized threaded plugs for all unused couplings at pole entrance points. Refer to Metal Pole Standard Drawing Sheet M3 for fabrication details.

Provide designs with a 6" x 12" hand hole with reinforcing frame for each pole.

Provide a terminal compartment with cover and screws in each pole encompassing the hand hole and containing a 12-terminal barrier type terminal block. Provide two (2) terminal screws with a removable shorting bar between them for each termination. Furnish terminal compartment covers attached to the pole by a sturdy chain or cable approved by the Engineer. Ensure chain or cable is long enough to permit cover to hang clear of the compartment opening when cover is removed and is strong enough to prevent vandalism. Ensure chain or cable will not interfere with service to cables in the pole base.

Have poles permanently stamped above the hand holes with the identification tag details as shown on Metal Pole Standard Drawing Sheets M2 and M3.

Provide grounding lug(s) in the approximate vicinity of the messenger cable clamp for bonding and grounding messenger cable. Lugs must accept #4 AWG wire to bond messenger cables to the pole in order to provide an effective ground fault circuit path. Refer to Metal Pole Standard Drawing Sheet M6 for construction details.

Install metal poles, hardware, and fittings as shown on the manufacturer's installation drawings. Ensure the installed pole, when fully loaded, is within 1 degree 40 minutes (1°40') of vertical. Install poles with the manufacturer's recommended "rake." Where required, use threaded leveling nuts to establish rake.

#### **5.2. DRILLED PIER FOUNDATIONS FOR METAL POLES**

Analysis procedures and formulas shall be based on AASHTO 6<sup>th</sup> Edition, latest ACI-318 code and the *Drilled Shafts: Construction Procedures and Design Methods* FHWA-NHI-10-016 manual. Design methods based on engineering publications or research papers must have prior approval from NCDOT. The Department reserves the right to accept or reject any method used for the analysis.

Use the following Safety Factors for the foundation design:

- 1.0 x Service (Unfactored) Loads for LPile Shaft Lateral Deflection
- 1.3 x Torsion (Unfactored) Load for Drilled Shaft Concrete and Steel Strength
- (1.3 / 1.33) x Torsion (Unfactored) Load for Shaft Soil-to-Concrete Torsion Capacity
- (2.0 / 1.33) x Axial (Unfactored) Load for Shaft Axial Capacity in Soil

Ensure deflection at top of foundation does not exceed 1 inch for worst-case lateral load.

Use LPILE Plus V6.0 or later for lateral analysis. Submit inputs, results and corresponding graphs with the design calculations.

Calculate skin friction using the  $\alpha$ -method for cohesive soils and the  $\beta$ -method for cohesion-less soils (**Broms method will not be accepted**). Detailed descriptions of the “ $\alpha$ ” and “ $\beta$ ” methods can be found in *FHWA-NHI-10-016*.

Omit first 2.5 feet for cohesive soils when calculating skin friction.

Assume a hammer efficiency of 0.70 unless value is provided.

All CCTV and MVD pole drilled shafts shall be a minimum of 4'-0" diameter. Refer to Standard Drawing Nos. M7 and M8.

Design custom foundations to carry maximum capacity of each metal pole. For standard case strain poles with custom design, use actual shear, axial and moment reactions from the Standard Strain Pole Foundation Selection Table shown on Standard Drawing No. M8.

When poor soil conditions are encountered, which could create an excessively large foundation design, consideration may be given to allow an exemption to the maximum capacity design. The Contractor must gain approval from the Engineer before reducing a foundation's capacity. On projects where poor soil is known to be present, the Contractor should have foundation designs approved before releasing poles for fabrication.

Have the Contractor notify the Engineer if the proposed foundation is to be installed on a slope other than 8H: 1V or flatter.

#### **A. Description:**

Furnish and install foundations for NCDOT metal poles with all necessary hardware in accordance with the plans and specifications.

Metal Pole Standards have been developed and implemented by NCDOT for use at signalized intersections in North Carolina. If the plans call for a standard strain pole, then a standard foundation may be selected from the plans. However, the Contractor is not required to use a standard foundation. If the Contractor chooses to design a non-standard site-specific foundation for a standard strain pole or if the plans call for a non-standard site-specific pole, design the foundation to conform to the applicable provisions in the NCDOT Metal Pole Standard Drawings and Section B4 (Non-Standard Foundation Design) below. If non-standard site-specific foundations are designed for standard QPL approved strain poles, the foundation designer must use the design moment specified by load case on Metal Pole Standard Drawing Sheet M8. Failure to conform to this requirement will be grounds for rejection of the design.

If the Contractor chooses to design a non-standard foundation for a standard strain pole and the soil test results indicate a standard foundation is feasible for the site, the Contractor will be paid the cost of the standard foundation. Any additional cost associated with a non-standard site-specific foundation including additional materials, labor and equipment will be considered incidental to the cost of the standard foundation. All costs for the non-standard foundation design will be considered incidental to the cost of the standard foundation.



**B. Soil Test and Foundation Determination:****1. General:**

Drilled piers are reinforced concrete sections, cast-in-place against in situ, undisturbed material. Drilled piers are of straight shaft type and vertical.

**2. Soil Test:**

Perform a soil test at each proposed metal pole location. Complete all required fill placement and excavation at each pole location to finished grade before drilling each boring. Soil tests performed that are not in compliance with this requirement may be rejected and will not be paid. Drill one boring to a depth of 26 feet within a 25-foot radius of each proposed foundation.

Perform standard penetration tests (SPT) in accordance with ASTM D 1586 at depths of 1, 2.5, 5, 7.5, 10, 15, 20 and 26 feet. Discontinue the boring if one of the following occurs:

- A total of 100 blows have been applied in any two consecutive 6-inch intervals.
- A total of 50 blows have been applied with < 3-inch penetration.

Describe each pole location along the project corridor in a manner that is easily discernible to both the Contractor's Designer and NCDOT Reviewers. If the pole is at an intersection, label the boring the "Intersection of (*Route or SR #*), (*Street Name*) and (*Route or SR #*), (*Street Name*), \_\_\_\_\_ County, Signal or Asset Inventory No. \_\_\_\_". Label borings with "B- *N, S, E, W, NE, NW, SE or SW*" corresponding to the quadrant location within the intersection.

If the pole location is located between intersections, provide a coordinate location and offset, or milepost number and offset. Pole numbers should be made available to the Drill Contractor. Include pole numbers in the boring label if they are available. If they are not available, ensure the boring labels can be cross-referenced to corresponding pole numbers. For each boring, submit a legible (hand-written or typed) boring log signed and sealed by a licensed Geologist or Professional Engineer registered in North Carolina. Include on each boring the SPT blow counts and N-values at each depth, depth of the boring, hammer efficiency, depth of water table and a general description of the soil types encountered using the AASHTO Classification System.

Borings that cannot be easily correlated to their specific pole location will be returned to the Contractor for clarification; or if approved by the Engineer, the foundation may be designed using the worst-case soil condition obtained as part of this project.

**3. Standard Foundation Determination:**

Use the following method for determining the Design N-value:

$$N_{AVG} = \frac{N_{@1'} + N_{@2.5'} + \dots + N_{@Deepest\ Boring\ Depth}}{Total\ Number\ of\ N\ values}$$

$$Y = (N_{@1'})^2 + (N_{@2.5'})^2 + \dots + (N_{@Deepest\ Boring\ Depth})^2$$

$$Z = N_{@1'} + N_{@2.5'} + \dots + N_{@Deepest\ Boring\ Depth}$$

$$N_{STD\ DEV} = \sqrt{\left( \frac{(Total\ Number\ of\ N\ values \times Y) - Z^2}{(Total\ Number\ of\ N\ values) \times (Total\ Number\ of\ N\ values - 1)} \right)}$$

**Design N-value** equals lesser of the following two conditions:

$$N_{AVG} - (N_{STD DEV} \times 0.45)$$

**OR**

$$\text{Average of First Four (4)N values} = \frac{N_{@1'} + N_{@2.5'} + N_{@5'} + N_{@7.5'}}{4}$$

*Note: If less than four (4) N-values are obtained because of criteria listed in Section 2 above, use average of N-values collected for second condition. Do not include the N-value at the deepest boring depth for above calculations if the boring is discontinued at or before the required boring depth because of criteria listed in Section 2 above. Use N-value of zero (0) for weight of hammer or weight of rod. If N-value is greater than fifty (50), reduce N-value to fifty (50) for calculations.*

If standard NCDOT strain poles are shown on the plans and the Contractor chooses to use standard foundations, determine a drilled pier length, "L," for each signal pole from the Standard Strain Pole Foundations Chart (sheet M8) based on the Design N-value and the predominant soil type. For each standard pole location, submit a completed "Metal Pole Standard Foundation Selection Form" signed by the Contractor's representative. Signature on form is for verification purposes only. Include the Design N-value calculation and resulting drilled pier length, "L," on each form.

If non-standard site-specific poles are shown on the plans, submit completed boring logs collected in accordance with Section 2 (Soil Test) along with pole loading diagrams from the plans to the Contractor-selected pole Fabricator to assist in the pole and foundation design.

If one of the following occurs, the Standard Foundations Chart shown on the plans may not be used and a non-standard foundation may be required. In such case, contact the Engineer.

- The Design N-value is less than four (4).
- The drilled pier length, "L", determined from the Standard Foundations Chart, is greater than the depth of the corresponding boring.

In the case where a standard foundation cannot be used, the Department will be responsible for the additional cost of the non-standard foundation.

Foundation designs are based on level ground around the traffic signal pole. If the slope around the edge of the drilled pier is steeper than 8:1 (H:V) or the proposed foundation will be less than 10 feet from the top of an embankment slope, the Contractor is responsible for providing slope information to the foundation Designer and to the Engineer so it can be considered in the design.

The "Metal Pole Standard Foundation Selection Form" may be found at:

<https://connect.ncdot.gov/resources/safety/Pages/ITS-Design-Resources.aspx>

If assistance is needed, contact the Engineer.

#### **4. Non-Standard Foundation Design:**

Design non-standard foundations based upon site-specific soil test information collected in accordance with Section 2 (Soil Test). Design drilled piers for side resistance in accordance with

Section 4.6 of the 2002 AASHTO Standard Specifications for Highway Bridges, 17<sup>th</sup> Edition. Use computer software LPILE version-6.0 or later manufactured by Ensoft, Inc. to analyze drilled piers. Use computer software gINT V8i or later manufactured by Bentley Systems, Inc. with the current NCDOT gINT library and data template to produce SPT boring logs. Provide a drilled pier foundation for each pole with a length and diameter resulting in horizontal lateral movement less than 1 inch at top of the pier, and horizontal rotational movement less than 1 inch at the edge of pier. Contact the Engineer for pole loading diagrams of standard poles used for non-standard foundation designs. Submit non-standard foundation designs including drawings, calculations, and soil boring logs to the Engineer for review and approval before construction.

**C. Drilled Pier Construction:**

Construct drilled pier foundation and Install anchor rod assemblies in accordance with the Foundations and Anchor Rod Assemblies for Metal Poles Standard Special Provision SP09-R005 located at:

<https://connect.ncdot.gov/resources/Specifications/Pages/2018-Specifications-and-Special-Provisions.aspx>

**5.3. POLE NUMBERING SYSTEM**

**A. New Poles**

Attach an identification tag to each pole shaft section as shown on Metal Pole Standard Sheet M2 “Typical Fabrication Details for All Metal Poles.”

**5.4. MEASUREMENT AND PAYMENT**

Actual number of metal strain signal poles (without regard to height or load capacity) furnished, installed and accepted.

Actual number of soil tests with SPT borings drilled furnished and accepted.

Actual volume of concrete poured in cubic yards of drilled pier foundation furnished, installed and accepted.

No measurement will be made for foundation designs prepared with metal pole designs, as these will be considered incidental to designing Traffic Signal , CCTV or MVD support structures.

**Payment will be made under:**

Metal Strain Signal Pole .....	Each
Soil Test .....	Each
Drilled Pier Foundation.....	Cubic Yard

# North Carolina Department of Transportation

**Letting ID:** L220222N  
02/22/2022 02:00:00 PM

**Contract ID:** DN00765  
**Call:** 001

Line Number	Item Number	Quantity	Unit	Unit Price	Extension Price
Section 0001 ROADWAY ITEMS					
0001	0000100000-N MOBILIZATION	1.000	LS	\$69,880.0000	\$69,880.00
0002	0000400000-N CONSTRUCTION SURVEYING	1.000	LS	\$16,000.0000	\$16,000.00
0003	0043000000-N GRADING	1.000	LS	\$106,400.0000	\$106,400.00
0004	0372000000-E 18" RC PIPE CULVERTS, CLASS III	390.000	LF	\$94.0000	\$36,660.00
0005	0448400000-E 24" RC PIPE CULVERTS, CLASS IV	180.000	LF	\$140.0000	\$25,200.00
0006	0576000000-E **" CS PIPE CULVERTS, ***** THICK (36"), (0.079")	11.000	LF	\$377.5400	\$4,152.94
0007	0582000000-E 15" CS PIPE CULVERTS, 0.064" THICK	10.000	LF	\$323.2300	\$3,232.30
0008	1297000000-E MILLING ASPHALT PAVEMENT, ****"DEPTH (3")	3000.000	SY	\$10.0000	\$30,000.00
0009	1308000000-E MILLING ASPHALT PAVEMENT, ****"TO *****" (3" TO 12")	500.000	SY	\$20.0000	\$10,000.00
0010	1491000000-E ASPHALT CONC BASE COURSE, TYPE B25.0C	800.000	TON	\$153.0000	\$122,400.00
0011	1503000000-E ASPHALT CONC INTERMEDIATE COURSE, TYPE I19.0C	730.000	TON	\$153.0000	\$111,690.00
0012	1523000000-E ASPHALT CONC SURFACE COURSE, TYPE S9.5C	1150.000	TON	\$162.6000	\$186,990.00
0013	1575000000-E ASPHALT BINDER FOR PLANT MIX	140.000	TON	\$650.0000	\$91,000.00
0014	1693000000-E ASPHALT PLANT MIX, PAVEMENT REPAIR	250.000	TON	\$162.6000	\$40,650.00
0015	2209000000-E ENDWALLS	3.000	CY	\$1,200.0000	\$3,600.00
0016	2253000000-E PIPE COLLARS	1.000	CY	\$1,200.0000	\$1,200.00
0017	2286000000-N MASONRY DRAINAGE STRUCTURES	10.000	EA	\$2,362.0000	\$23,620.00
0018	2374000000-N FRAME WITH GRATE & HOOD, STD 840.03, TYPE ** (TYPE F)	2.000	EA	\$667.0000	\$1,334.00
0019	2374000000-N FRAME WITH GRATE & HOOD, STD 840.03, TYPE ** (TYPE G)	5.000	EA	\$655.2000	\$3,276.00
0020	2396000000-N FRAME WITH COVER, STD 840.54	2.000	EA	\$355.2000	\$710.40
0021	2407000000-N STEEL FRAME WITH TWO GRATES, STD 840.37	1.000	EA	\$1,872.0000	\$1,872.00
0022	2549000000-E 2'-6" CONCRETE CURB & GUTTER	1030.000	LF	\$53.0000	\$54,590.00
0023	2612000000-E 6" CONCRETE DRIVEWAY	100.000	SY	\$135.0000	\$13,500.00

0024	2619000000-E	250.000	SY	\$95.0000	\$23,750.00
	4" CONCRETE PAVED DITCH				
0025	2830000000-N	3.000	EA	\$750.0000	\$2,250.00
	ADJUSTMENT OF MANHOLES				
0026	2845000000-N	3.000	EA	\$750.0000	\$2,250.00
	ADJUSTMENT OF METER BOXES OR VALVE BOXES				
0027	3030000000-E	60.000	LF	\$42.0000	\$2,520.00
	STEEL BEAM GUARDRAIL				
0028	3210000000-N	1.000	EA	\$1,800.0000	\$1,800.00
	GUARDRAIL END UNITS, TYPE CAT-1				
0029	3287000000-N	1.000	EA	\$4,980.0000	\$4,980.00
	GUARDRAIL END UNITS, TYPE TL-3				
0030	3566000000-E	10.000	LF	\$175.0000	\$1,750.00
	WOVEN WIRE FENCE RESET				
0031	3574000000-E	35.000	LF	\$150.0000	\$5,250.00
	GENERIC FENCING ITEM C.A. FENCE REMOVAL				
0032	3649000000-E	100.000	TON	\$80.0000	\$8,000.00
	RIP RAP, CLASS B				
0033	3656000000-E	120.000	SY	\$5.0000	\$600.00
	GEOTEXTILE FOR DRAINAGE				
0034	4072000000-E	50.000	LF	\$7.8000	\$390.00
	SUPPORTS, 3-LB STEEL U-CHANNEL				
0035	4116100000-N	1.000	EA	\$210.0000	\$210.00
	SIGN ERECTION, RELOCATE TYPE **** (GROUND MOUNTED) (TYPE D)				
0036	4116100000-N	10.000	EA	\$120.0000	\$1,200.00
	SIGN ERECTION, RELOCATE TYPE **** (GROUND MOUNTED) (TYPE E)				
0037	4186000000-N	5.000	EA	\$192.1500	\$960.75
	STOCKPILE SUPPORT, U-CHANNEL				
0038	4192000000-N	5.000	EA	\$12.0000	\$60.00
	DISPOSAL OF SUPPORT, U-CHANNEL				
0039	4400000000-E	160.000	SF	\$8.3200	\$1,331.20
	WORK ZONE SIGNS (STATIONARY)				
0040	4405000000-E	192.000	SF	\$13.2000	\$2,534.40
	WORK ZONE SIGNS (PORTABLE)				
0041	4415000000-N	4.000	EA	\$2,880.0000	\$11,520.00
	FLASHING ARROW BOARD				
0042	4420000000-N	4.000	EA	\$8,064.0000	\$32,256.00
	PORTABLE CHANGEABLE MESSAGE SIGN				
0043	4430000000-N	150.000	EA	\$53.8000	\$8,070.00
	DRUMS				
0044	4455000000-N	40.000	DAY	\$1,020.0000	\$40,800.00
	FLAGGER				
0045	4480000000-N	2.000	EA	\$10,800.0000	\$21,600.00
	TMA				
0046	4507000000-E	200.000	LF	\$19.2000	\$3,840.00
	WATER FILLED BARRIER				
0047	4516000000-N	100.000	EA	\$47.3900	\$4,739.00
	SKINNY DRUM				
0048	4695000000-E	1000.000	LF	\$1.8000	\$1,800.00

THERMOPLASTIC PAVEMENT MARKING LINES (8", 90 MILS)				
0049	4720000000-E	8.000	EA	\$240.0000 \$1,920.00
THERMOPLASTIC PAVEMENT MARKING CHARACTER (90 MILS)				
0050	4725000000-E	29.000	EA	\$120.0000 \$3,480.00
THERMOPLASTIC PAVEMENT MARKING SYMBOL (90 MILS)				
0051	4810000000-E	3110.000	LF	\$0.7200 \$2,239.20
PAINT PAVEMENT MARKING LINES (4")				
0052	4870000000-E	15.000	LF	\$7.2000 \$108.00
REMOVAL OF PAVEMENT MARKING LINES (24")				
0053	4890000000-E	5800.000	LF	\$1.8000 \$10,440.00
GENERIC PAVEMENT MARKING ITEM 4" 60 MIL YELLOW THERMOPLASTIC PAVEMENT MARKING LINES				
0054	4891000000-E	72.000	LF	\$6.0000 \$432.00
GENERIC PAVEMENT MARKING ITEM 24" 90 MIL WHITE THERMOPLASTIC PAVEMENT MARKING LINES				
0055	4895000000-N	48.000	EA	\$96.0000 \$4,608.00
GENERIC PAVEMENT MARKING ITEM NON-CAST IRON SNOWPLOWABLE PAVEMENT MARKERS				
0056	6000000000-E	820.000	LF	\$10.8000 \$8,856.00
TEMPORARY SILT FENCE				
0057	6006000000-E	30.000	TON	\$75.0000 \$2,250.00
STONE FOR EROSION CONTROL, CLASS A				
0058	6009000000-E	20.000	TON	\$75.0000 \$1,500.00
STONE FOR EROSION CONTROL, CLASS B				
0059	6012000000-E	65.000	TON	\$75.0000 \$4,875.00
SEDIMENT CONTROL STONE				
0060	6015000000-E	2.500	ACR	\$2,736.0000 \$6,840.00
TEMPORARY MULCHING				
0061	6018000000-E	300.000	LB	\$3.6000 \$1,080.00
SEED FOR TEMPORARY SEEDING				
0062	6021000000-E	2.000	TON	\$3,000.0000 \$6,000.00
FERTILIZER FOR TEMPORARY SEEDING				
0063	6024000000-E	200.000	LF	\$36.6800 \$7,336.00
TEMPORARY SLOPE DRAINS				
0064	6029000000-E	800.000	LF	\$4.8000 \$3,840.00
SAFETY FENCE				
0065	6030000000-E	50.000	CY	\$30.0000 \$1,500.00
SILT EXCAVATION				
0066	6036000000-E	10000.000	SY	\$2.4000 \$24,000.00
MATTING FOR EROSION CONTROL				
0067	6042000000-E	240.000	LF	\$6.0000 \$1,440.00
1/4" HARDWARE CLOTH				
0068	6071012000-E	260.000	LF	\$14.4000 \$3,744.00
COIR FIBER WATTLE				
0069	6071020000-E	12.000	LB	\$20.0000 \$240.00
POLYACRYLAMIDE (PAM)				
0070	6084000000-E	3.000	ACR	\$5,760.0000 \$17,280.00
SEEDING & MULCHING				
0071	6090000000-E	50.000	LB	\$3.6000 \$180.00
SEED FOR REPAIR SEEDING				

0072	6093000000-E	0.250 TON	\$3,000.0000	\$750.00
	FERTILIZER FOR REPAIR SEEDING			
0073	6096000000-E	75.000 LB	\$3.6000	\$270.00
	SEED FOR SUPPLEMENTAL SEEDING			
0074	6108000000-E	2.250 TON	\$3,000.0000	\$6,750.00
	FERTILIZER TOPDRESSING			
0075	6114500000-N	10.000 MHR	\$150.0000	\$1,500.00
	SPECIALIZED HAND MOWING			
0076	6117000000-N	8.000 EA	\$720.0000	\$5,760.00
	RESPONSE FOR EROSION CONTROL			
0077	6117500000-N	2.000 EA	\$650.0000	\$1,300.00
	CONCRETE WASHOUT STRUCTURE			
0078	6132000000-N	1.000 EA	\$400.0000	\$400.00
	GENERIC EROSION CONTROL ITEM FABRIC INSERT INLET PROTECTION DEVICE			
0079	6132000000-N	1.000 EA	\$250.0000	\$250.00
	GENERIC EROSION CONTROL ITEM FABRIC INSERT INLET PROTECTION DEVICE CLEAN OUT			
0080	7060000000-E	3500.000 LF	\$3.6000	\$12,600.00
	SIGNAL CABLE			
0081	7120000000-E	12.000 EA	\$1,020.0000	\$12,240.00
	VEHICLE SIGNAL HEAD (12", 3 SECTION)			
0082	7264000000-E	1200.000 LF	\$6.0000	\$7,200.00
	MESSENGER CABLE (3/8")			
0083	7300000000-E	3600.000 LF	\$12.8900	\$46,404.00
	UNPAVED TRENCHING (***** (1) (2"))			
0084	7300000000-E	350.000 LF	\$21.6000	\$7,560.00
	UNPAVED TRENCHING (***** (2) (2"))			
0085	7300000000-E	20.000 LF	\$60.0000	\$1,200.00
	UNPAVED TRENCHING (***** (4) (2"))			
0086	7324000000-N	9.000 EA	\$660.0000	\$5,940.00
	JUNCTION BOX (STANDARD SIZE)			
0087	7444000000-E	1100.000 LF	\$10.5000	\$11,550.00
	INDUCTIVE LOOP SAWCUT			
0088	7456000000-E	9000.000 LF	\$2.1000	\$18,900.00
	LEAD-IN CABLE (***** (14-2)			
0089	7576000000-N	4.000 EA	\$16,800.0000	\$67,200.00
	METAL STRAIN SIGNAL POLE			
0090	7613000000-N	4.000 EA	\$1,290.0000	\$5,160.00
	SOIL TEST			
0091	7614100000-E	24.000 CY	\$1,860.0000	\$44,640.00
	DRILLED PIER FOUNDATION			
0092	7630000000-N	4.000 EA	\$300.0000	\$1,200.00
	METAL STRAIN POLE DESIGN			
0093	7636000000-N	2.000 EA	\$600.0000	\$1,200.00
	SIGN FOR SIGNALS			
0094	7980000000-N	3.000 EA	\$21,600.0000	\$64,800.00
	GENERIC SIGNAL ITEM MICROWAVE VEHICLE DETECTION SYSTEM - MULTIPLE ZONES			
0095	7360000000-N	4.000 EA	\$930.0000	\$3,720.00
	WOOD POLE			
0096	7372000000-N	8.000 EA	\$720.0000	\$5,760.00



GUY ASSEMBLY

0097	7408000000-E	1.000 EA	\$480.0000	\$480.00
	1" RISER WITH WEATHERHEAD			
0098	7420000000-E	5.000 EA	\$930.0000	\$4,650.00
	2" RISER WITH WEATHERHEAD			
0099	7575180000-N	8.000 EA	\$240.0000	\$1,920.00
	CABLE TRANSFER			
0100	7684000000-N	1.000 EA	\$3,600.0000	\$3,600.00
	SIGNAL CABINET FOUNDATION			
0101	7756000000-N	1.000 EA	\$19,200.0000	\$19,200.00
	CONTROLLER WITH CABINET (TYPE 2070L, BASE MOUNTED)			
0102	7780000000-N	5.000 EA	\$156.0000	\$780.00
	DETECTOR CARD (TYPE 2070L)			
0103	7901000000-N	1.000 EA	\$420.0000	\$420.00
	CABINET BASE EXTENDER			
0104	7948000000-N	2.000 EA	\$2,400.0000	\$4,800.00
	TRAFFIC SIGNAL REMOVAL			
Section 0001 Total				\$1,626,711.19
Item Total				\$1,626,711.19

**ELECTRONIC BID SUBMISSION**

By submitting this bid electronically, I hereby acknowledge that all requirements included in the hard copy proposal, addendum, amendments, plans, standard specifications, supplemental specifications and special provisions are part of the bid and contract. Further, I acknowledge that I have read, understand, accept, acknowledge and agree to comply with all statements in this electronic bid.

=====

**NON-COLLUSION, DEBARMENT AND GIFT BAN CERTIFICATION**

The prequalified bidder declares (or certifies, verifies, or states) under penalty of perjury under the laws of the United States that neither he, nor any official, agent or employee has entered into any agreement, participated in any collusion, or otherwise taken any action which is in restraint of free competitive bidding in connection with any bid or contract, that the prequalified bidder has not been convicted of violating N.C.G.S. §133-24 within the last three years, and that the prequalified bidder intends to do the work with his own bonafide employees or subcontractors and will not bid for the benefit of another contractor.

By submitting this non-collusion, debarment and gift ban certification, the Contractor is attesting his status under penalty of perjury under the laws of the United States in accordance with the Debarment Certification attached, provided that the Debarment Certification also includes any required statements concerning exceptions that are applicable.

N.C.G.S. §133-32 and Executive Order 24 prohibit the offer to, or acceptance by, any State Employee of any gift from anyone with a contract with the State, or from any person seeking to do business with the State. By execution of any response in this procurement, you attest, for your entire organization and its employees or agents, that you are not aware that any such gift has been offered, accepted, or promised by any employees of your organization.

**DEBARMENT CERTIFICATION OF PREQUALIFIED BIDDER**

Conditions for certification:

1. The prequalified bidder shall provide immediate written notice to the Department if at any time the bidder learns that his certification was erroneous when he submitted his debarment certification or explanation that is file with the Department, or has become erroneous because of changed circumstances.
2. The terms covered transaction, debarred, suspended, ineligible, lower tier

covered transaction, participant, person, primary covered transaction, principal, proposal, and voluntarily excluded, as used in this provision, have the meanings set out in the Definitions and Coverage sections of the rules implementing Executive Order 12549. A copy of the Federal Rules requiring this certification and detailing the definitions and coverages may be obtained from the Contract Officer of the Department.

3. The prequalified bidder agrees by submitting this form, that he will not knowingly enter into any lower tier covered transaction with a person who is debarred, suspended, declared ineligible, or voluntarily excluded from participation in NCDOT contracts, unless authorized by the Department.

4. For Federal Aid projects, the prequalified bidder further agrees that by submitting this form he will include the Federal- Aid Provision titled Required Contract Provisions Federal-Aid Construction Contract (Form FHWA PR 1273) provided by the Department, without subsequent modification, in all lower tier covered transactions.

5. The prequalified bidder may rely upon a certification of a participant in a lower tier covered transaction that he is not debarred, suspended, ineligible, or voluntarily excluded from the covered transaction, unless he knows that the certification is erroneous. The bidder may decide the method and frequency by which he will determine the eligibility of his subcontractors.

6. Nothing contained in the foregoing shall be construed to require establishment of a system of records in order to render in good faith the certification required by this provision. The knowledge and information of a participant is not required to exceed that which is normally possessed by a prudent person in the ordinary course of business dealings.

7. Except as authorized in paragraph 6 herein, the Department may terminate any contract if the bidder knowingly enters into a lower tier covered transaction with a person who is suspended, debarred, ineligible, or voluntarily excluded from participation in this transaction, in addition to other remedies available by the Federal Government.

#### **DEBARMENT CERTIFICATION**

The prequalified bidder certifies to the best of his knowledge and belief, that he and his principals:

a. Are not presently debarred, suspended, proposed for debarment, declared ineligible, or voluntarily excluded from covered transactions by any Federal department or agency;

b. Have not within a three-year period preceding this proposal been convicted of or had a civil judgment rendered against them for commission of fraud or a criminal offense in connection with obtaining, attempting to obtain, or performing a public (Federal, State or local) transaction or contract under a public transaction; violation of Federal or State antitrust statutes or

commission of embezzlement, theft, forgery, bribery, falsification or destruction of records; making false statements; or receiving stolen property;

c. Are not presently indicted for or otherwise criminally or civilly charged by a governmental entity (Federal, State or local) with commission of any of the offenses enumerated in paragraph b. of this certification; and

d. Have not within a three-year period preceding this proposal had one or more public transactions (Federal, State or local) terminated for cause or default.

e. Will submit a revised Debarment Certification immediately if his status changes and will show in his bid proposal an explanation for the change in status.

If the prequalified bidder cannot certify that he is not debarred, he shall provide an explanation with this submittal. An explanation will not necessarily result in denial of participation in a contract.

Failure to submit a non-collusion and debarment certification will result in the prequalified bidder's bid being considered non-responsive.

**EXPLANATION:**

### DBE List Summary

Project: 0441017

Bidder ID: 9620

Bid Total: 1,626,711.19

Business Name: Bryson Enterprises LTD

Goal: 5.00% (81,335.56)

Total Entered: 6.12% (99,519.60)

<b>ID</b>	<b>Name</b>	<b>Is Supplier?</b>	<b>Item Count</b>	<b>Amount</b>	<b>Is Complete?</b>
15649	hickory sealing and striping	False	8	25,027.20	True
4898	bullington construction	False	3	9,300.00	True
2209	b c cannon	False	7	65,192.40	True

Name: hickory sealing and striping ID: 15649

Address: 2300 monteith lane

Used As: SubContractor DBE Items Total:\$25,027.20

**Items for hickory sealing and striping**

0001 ROADWAY ITEMS				
0048	4695000000-E	1000.000 LF	\$1.8000	\$1,800.00
	THERMOPLASTIC PAVEMENT MARKING LINES (8", 90 MILS)			
0049	4720000000-E	8.000 EA	\$240.0000	\$1,920.00
	THERMOPLASTIC PAVEMENT MARKING CHARACTER (90 MILS)			
0050	4725000000-E	29.000 EA	\$120.0000	\$3,480.00
	THERMOPLASTIC PAVEMENT MARKING SYMBOL (90 MILS)			
0051	4810000000-E	3110.000 LF	\$0.7200	\$2,239.20
	PAINT PAVEMENT MARKING LINES (4")			
0052	4870000000-E	15.000 LF	\$7.2000	\$108.00
	REMOVAL OF PAVEMENT MARKING LINES (24")			
0053	4890000000-E	5800.000 LF	\$1.8000	\$10,440.00
	GENERIC PAVEMENT MARKING ITEM 4" 60 MIL YELLOW THERMOPLASTIC PAVEMENT MARKING LINES			
0054	4891000000-E	72.000 LF	\$6.0000	\$432.00
	GENERIC PAVEMENT MARKING ITEM 24" 90 MIL WHITE THERMOPLASTIC PAVEMENT MARKING LINES			
0055	4895000000-N	48.000 EA	\$96.0000	\$4,608.00
	GENERIC PAVEMENT MARKING ITEM NON-CAST IRON SNOWPLOWABLE PAVEMENT MARKERS			
Section 0001 Total				\$25,027.20
Item Total				\$25,027.20

Name: bullington construction ID: 4898

Address: 164 american dr

Used As: SubContractor DBE Items Total:\$9,300.00

**Items for bullington construction**

---

0001	ROADWAY ITEMS			
0027	3030000000-E	60.000 LF	\$42.0000	\$2,520.00
	STEEL BEAM GUARDRAIL			
0028	3210000000-N	1.000 EA	\$1,800.0000	\$1,800.00
	GUARDRAIL END UNITS, TYPE CAT-1			
0029	3287000000-N	1.000 EA	\$4,980.0000	\$4,980.00
	GUARDRAIL END UNITS, TYPE TL-3			
Section 0001 Total				\$9,300.00
Item Total				\$9,300.00

---

Name: b c cannon ID: 2209

Address: 2501 rutherford rd

Used As: SubContractor DBE Items Total:\$65,192.40

**Items for b c cannon**

0001 ROADWAY ITEMS					
0035	4116100000-N	1.000	EA	\$210.0000	\$210.00
	SIGN ERECTION, RELOCATE TYPE **** (GROUND MOUNTED) (TYPE D)				
0036	4116100000-N	10.000	EA	\$120.0000	\$1,200.00
	SIGN ERECTION, RELOCATE TYPE **** (GROUND MOUNTED) (TYPE E)				
0039	4400000000-E	160.000	SF	\$7.8000	\$1,248.00
	WORK ZONE SIGNS (STATIONARY)				
0040	4405000000-E	192.000	SF	\$13.2000	\$2,534.40
	WORK ZONE SIGNS (PORTABLE)				
0041	4415000000-N	4.000	EA	\$2,880.0000	\$11,520.00
	FLASHING ARROW BOARD				
0042	4420000000-N	4.000	EA	\$6,720.0000	\$26,880.00
	PORTABLE CHANGEABLE MESSAGE SIGN				
0045	4480000000-N	2.000	EA	\$10,800.0000	\$21,600.00
	TMA				
Section 0001 Total					\$65,192.40
Item Total					\$65,192.40



THIS PROPOSAL CONTAINS THE FOLLOWING ERRORS/WARNINGS (IF ANY)

This Bid contains 2 amendment files

000001 02/10/2022 PAY ITEM ADDITIONS, QTY INCREASES, REVISED CONTRACT TIMES  
000002 02/14/2022 ADDITION OF PAY ITEMS AND A PROVISION

**Electronic Bid Submission**

By submitting this bid electronically, I hereby acknowledge that all requirements included in the hard copy proposal, addendum, amendments, plans, standard specifications, supplemental specifications and special provisions are part of the bid and contract. Further, I acknowledge that I have read, understand, accept, acknowledge and agree to comply with all statements in this electronic bid.

I hereby certify that I have the authority to submit this bid.

Signature \_\_\_\_\_

Agency \_\_\_\_\_

Date \_\_\_\_\_

Signature \_\_\_\_\_

Agency \_\_\_\_\_

Date \_\_\_\_\_

Signature \_\_\_\_\_

Agency \_\_\_\_\_

Date \_\_\_\_\_

## Attachments

Failure to complete and attach the Fuel Usage Factor Adjustment Form will result in using 2.90 gallons per ton as the Fuel Usage Factor for Diesel for the asphalt items included on the form. The contractor will not be permitted to change the option after the bids are submitted.

NOTE: The maximum upload limit is 5 MB.

Verify



STATE OF NORTH CAROLINA  
DEPARTMENT OF TRANSPORTATION

LETTER OF INTENT TO PERFORM AS A SUBCONTRACTOR

CONTRACT:  
DN00765

NAME OF BIDDER:  
Bryson Grading and Paving

The undersigned intends to perform work in connection with the above contract upon execution of the bid and subsequent award of contract by the Board of Transportation as:

Name of MBE/WBE/DBE Subcontractor Hickory Sealing and Striping, Inc.

Address 2300 Monteith Lane

City Connelly Springs State NC Zip 28612

Please check all that apply:

Minority Business Enterprise (MBE)

Women Business Enterprise (WBE)

Disadvantaged Business Enterprise (DBE)

The MBE /WBE /DBE status of the above named subcontractor is certified by the North Carolina Department of Transportation. The above named subcontractor is prepared to perform the described work listed on the attached MBE/WBE/DBE Commitment Items sheet, in connection with the above contract upon execution of the bid and subsequent award of contract by the Board of Transportation. The above named subcontractor is prepared to perform the described work at the estimated Commitment Total for Subcontractor Price identified on the MBE/WBE/DBE Commitment Items sheet and amount indicated below.

Commitment Total based on estimated Unit Prices and Quantities on the "attached" MBE/WBE/DBE Commitment Items sheet. Amount \$ 25,027.20

The above named bidder and subcontractor mutually accepts the Commitment Total estimated for the Unit Prices and Quantities. This commitment total is based on estimated quantities only and most likely will vary up or down as the project is completed. Final compensation will be based on actual quantities of work performed and accepted during the pursuance of work. The above listed amount represents the entire dollar amount quoted based on these estimated quantities. No conversations, verbal agreements, and/or other forms of non-written representations shall serve to add, delete, or modify the terms as stated.

This document shall not serve in any manner as an actual subcontract between the two parties. A separate subcontractor agreement will describe in detail the contractual obligations of the bidder and the MBE/WBE/DBE subcontractor.

**Affirmation**

The above named MBE/ WBE/ DBE subcontractor affirms that it will perform the portion(s) of the contract for the estimated dollar value as stated above.

Hickory Sealing and Striping Inc.  
Name of MBE/ WBE/ DBE Subcontractor

Willy Williams, President  
Signature / Title

2-28-22

Date

Bryson Enterprises LTD  
Name of Bidder

[Signature] Sales and Estimating  
Signature / Title

2/28/22

Date



**STATE OF NORTH CAROLINA  
DEPARTMENT OF TRANSPORTATION**

LETTER OF INTENT TO PERFORM AS A SUBCONTRACTOR

CONTRACT:  
DN00765

NAME OF BIDDER:  
Bryson Grading & Paving

The undersigned intends to perform work in connection with the above contract upon execution of the bid and subsequent award of contract by the Board of Transportation as:

Name of MBE/WBE/DBE Subcontractor B.C. Cannon Company

Address 2501 Rutherford

City Greenville State SC Zip 29609

Please check all that apply:

Minority Business Enterprise (MBE)

Women Business Enterprise (WBE)

Disadvantaged Business Enterprise (DBE)

The MBE /WBE /DBE status of the above named subcontractor is certified by the North Carolina Department of Transportation. The above named subcontractor is prepared to perform the described work listed on the attached MBE/WBE/DBE Commitment Items sheet, in connection with the above contract upon execution of the bid and subsequent award of contract by the Board of Transportation. The above named subcontractor is prepared to perform the described work at the estimated Commitment Total for Subcontractor Price identified on the MBE/WBE/DBE Commitment Items sheet and amount indicated below.

Commitment Total based on estimated Unit Prices and Quantities on the "attached" MBE/WBE/DBE Commitment Items sheet. Amount \$ 65,192.40

The above named bidder and subcontractor mutually accepts the Commitment Total estimated for the Unit Prices and Quantities. This commitment total is based on estimated quantities only and most likely will vary up or down as the project is completed. Final compensation will be based on actual quantities of work performed and accepted during the pursuance of work. The above listed amount represents the entire dollar amount quoted based on these estimated quantities. No conversations, verbal agreements, and/or other forms of non-written representations shall serve to add, delete, or modify the terms as stated.

This document shall not serve in any manner as an actual subcontract between the two parties. A separate subcontractor agreement will describe in detail the contractual obligations of the bidder and the MBE/WBE/DBE subcontractor.

**Affirmation**

The above named MBE/ WBE/ DBE subcontractor affirms that it will perform the portion(s) of the contract for the estimated dollar value as stated above.

**B.C. Cannon Company**

**Bryson Grading & Paving**

Name of MBE/ WBE/ DBE Subcontractor

Name of Bidder

Wade Cannon, CEO  
Signature / Title

[Signature] Sales and Estimating  
Signature / Title

2/28/22  
Date

2/28/22  
Date

Date

Contract No. DN00765  
County Macon

Rev. 1-16-18

**EXECUTION OF CONTRACT  
NON-COLLUSION, DEBARMENT AND GIFT BAN CERTIFICATION**

**CORPORATION**

The Contractor declares (or certifies, verifies, or states) under penalty of perjury under the laws of the United States that neither he, nor any official, agent or employee has entered into any agreement, participated in any collusion, or otherwise taken any action which is in restraint of free competitive bidding in connection with this Contract, that the Contractor has not been convicted of violating *N.C.G.S. § 133-24* within the last three years, and that the Contractor intends to do the work with its own bona fide employees or subcontractors and did not bid for the benefit of another contractor.

By submitting this Execution of Contract, Non-Collusion and Debarment Certification, the Contractor is certifying his status under penalty of perjury under the laws of the United States in accordance with the Debarment Certification attached, provided that the Debarment Certification also includes any required statements concerning exceptions that are applicable.

*N.C.G.S. § 133-32* and Executive Order 24 prohibit the offer to, or acceptance by, any State Employee of any gift from anyone with a contract with the State, or from any person seeking to do business with the State. By execution of any response in this procurement, you attest, for your entire organization and its employees or agents, that you are not aware that any such gift has been offered, accepted, or promised by any employees of your organization.

**SIGNATURE OF CONTRACTOR**

Bryson Enterprises, Ltd dba Bryson Grading & Paving

Full name of Corporation

PO Box 1691, Highlands, NC 28741

Address as Prequalified

Attest *Becki Bryson*  
Secretary/Assistant Secretary  
*Select appropriate title*

By *Ryan Bryson*  
President/Vice President/Assistant Vice President  
*Select appropriate title*

Becki Bryson

Print or type Signer's name

Ryan Bryson

Print or type Signer's name

**CORPORATE SEAL**

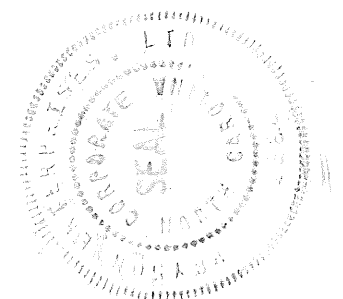

## DEBARMENT CERTIFICATION

### Conditions for certification:

1. The prequalified bidder shall provide immediate written notice to the Department if at any time the bidder learns that his certification was erroneous when he submitted his debarment certification or explanation filed with the Department, or has become erroneous because of changed circumstances.
2. The terms *covered transaction, debarred, suspended, ineligible, lower tier covered transaction, participant, person, primary covered transaction, principal, proposal, and voluntarily excluded*, as used in this provision, have the meanings set out in the Definitions and Coverage sections of the rules implementing Executive Order 12549. A copy of the Federal Rules requiring this certification and detailing the definitions and coverages may be obtained from the Contract Officer of the Department.
3. The prequalified bidder agrees by submitting this form, that he will not knowingly enter into any lower tier covered transaction with a person who is debarred, suspended, declared ineligible, or voluntarily excluded from participation in NCDOT contracts, unless authorized by the Department.
4. For Federal Aid projects, the prequalified bidder further agrees that by submitting this form he will include the Federal-Aid Provision titled *Required Contract Provisions Federal-Aid Construction Contract (Form FHWA PR 1273)* provided by the Department, without subsequent modification, in all lower tier covered transactions.
5. The prequalified bidder may rely upon a certification of a participant in a lower tier covered transaction that he is not debarred, suspended, ineligible, or voluntarily excluded from the covered transaction, unless he knows that the certification is erroneous. The bidder may decide the method and frequency by which he will determine the eligibility of his subcontractors.
6. Nothing contained in the foregoing shall be construed to require establishment of a system of records in order to render in good faith the certification required by this provision. The knowledge and information of a participant is not required to exceed that which is normally possessed by a prudent person in the ordinary course of business dealings.
7. Except as authorized in paragraph 6 herein, the Department may terminate any contract if the bidder knowingly enters into a lower tier covered transaction with a person who is suspended, debarred, ineligible, or voluntarily excluded from participation in this transaction, in addition to other remedies available by the Federal Government.

### DEBARMENT CERTIFICATION

The prequalified bidder certifies to the best of his knowledge and belief, that he and his principals:

- a. Are not presently debarred, suspended, proposed for debarment, declared ineligible, or voluntarily excluded from covered transactions by any Federal department or agency;
- b. Have not within a three-year period preceding this proposal been convicted of or had a civil judgment rendered against them for commission of fraud or a criminal offense in connection with obtaining, attempting to obtain, or performing a public (Federal, State or local) transaction or contract under a public transaction; violation of Federal or State antitrust statutes or commission of embezzlement, theft, forgery, bribery, falsification or destruction of records; making false statements; or receiving stolen property;
- c. Are not presently indicted for or otherwise criminally or civilly charged by a governmental entity (Federal, State or local) with commission of any of the offenses enumerated in paragraph b. of this certification; and
- d. Have not within a three-year period preceding this proposal had one or more public transactions (Federal, State or local) terminated for cause or default.
- e. Will submit a revised Debarment Certification immediately if his status changes and will show in his bid proposal an explanation for the change in status.

If the prequalified bidder cannot certify that he is not debarred, he shall provide an explanation with this submittal. An explanation will not necessarily result in denial of participation in a contract.

Failure to submit a non-collusion and debarment certification will result in the prequalified bidder's bid being considered non-responsive.

Check here if an explanation is attached to this certification.

Line #	ItemNumber	Sec #	Description	Quantity Unit	Unit Bid Price	Amount Bid
<b>ROADWAY ITEMS</b>						
0001	0000100000-N	800	MOBILIZATION	Lump Sum LS	69,880.00	69,880.00
0002	0000400000-N	801	CONSTRUCTION SURVEYING	Lump Sum LS	16,000.00	16,000.00
0003	0043000000-N	226	GRADING	Lump Sum LS	106,400.00	106,400.00
0004	0372000000-E	310	18" RC PIPE CULVERTS, CLASS III	390 LF	94.00	36,660.00
0005	0448400000-E	310	24" RC PIPE CULVERTS, CLASS IV	180 LF	140.00	25,200.00
0006	0576000000-E	310	*** CS PIPE CULVERTS, ***** THICK (36"), (0.079")	11 LF	377.54	4,152.94
0007	0582000000-E	310	15" CS PIPE CULVERTS, 0.064" THICK	10 LF	323.23	3,232.30
0008	1297000000-E	607	MILLING ASPHALT PAVEMENT, ***** DEPTH (3")	3,000 SY	10.00	30,000.00
0009	1308000000-E	607	MILLING ASPHALT PAVEMENT, ***** TO ***** (3" TO 12")	500 SY	20.00	10,000.00
0010	1491000000-E	610	ASPHALT CONC BASE COURSE, TYPE B25.0C	800 TON	153.00	122,400.00
0011	1503000000-E	610	ASPHALT CONC INTERMEDIATE COURSE, TYPE I19.0C	730 TON	153.00	111,690.00
0012	1523000000-E	610	ASPHALT CONC SURFACE COURSE, TYPE S9.5C	1,150 TON	162.60	186,990.00
0013	1575000000-E	620	ASPHALT BINDER FOR PLANT MIX	140 TON	650.00	91,000.00
0014	1693000000-E	654	ASPHALT PLANT MIX, PAVEMENT REPAIR	250 TON	162.60	40,650.00
0015	2209000000-E	838	ENDWALLS	3 CY	1,200.00	3,600.00
0016	2253000000-E	840	PIPE COLLARS	1 CY	1,200.00	1,200.00
0017	2286000000-N	840	MASONRY DRAINAGE STRUCTURES	10 EA	2,362.00	23,620.00



## Contract Item Sheets For DN00765

Line #	ItemNumber	Sec #	Description	Quantity Unit	Unit Bid Price	Amount Bid
0018	2374000000-N	840	FRAME WITH GRATE & HOOD, STD 840.03, TYPE ** (TYPE F)	2 EA	667.00	1,334.00
0019	2374000000-N	840	FRAME WITH GRATE & HOOD, STD 840.03, TYPE ** (TYPE G)	5 EA	655.20	3,276.00
0020	2396000000-N	840	FRAME WITH COVER, STD 840.54	2 EA	355.20	710.40
0021	2407000000-N	840	STEEL FRAME WITH TWO GRATES, STD 840.37	1 EA	1,872.00	1,872.00
0022	2549000000-E	846	2'-6" CONCRETE CURB & GUTTER	1,030 LF	53.00	54,590.00
0023	2612000000-E	848	6" CONCRETE DRIVEWAY	100 SY	135.00	13,500.00
0024	2619000000-E	850	4" CONCRETE PAVED DITCH	250 SY	95.00	23,750.00
0025	2830000000-N	858	ADJUSTMENT OF MANHOLES	3 EA	750.00	2,250.00
0026	2845000000-N	858	ADJUSTMENT OF METER BOXES OR VALVE BOXES	3 EA	750.00	2,250.00
0027	3030000000-E	862	STEEL BEAM GUARDRAIL	60 LF	42.00	2,520.00
0028	3210000000-N	862	GUARDRAIL END UNITS, TYPE CAT-1	1 EA	1,800.00	1,800.00
0029	3287000000-N	SP	GUARDRAIL END UNITS, TYPE TL-3	1 EA	4,980.00	4,980.00
0030	3566000000-E	867	WOVEN WIRE FENCE RESET	10 LF	175.00	1,750.00
0031	3574000000-E	867	GENERIC FENCING ITEM C.A. FENCE REMOVAL	35 LF	150.00	5,250.00
0032	3649000000-E	876	RIP RAP, CLASS B	100 TON	80.00	8,000.00
0033	3656000000-E	876	GEOTEXTILE FOR DRAINAGE	120 SY	5.00	600.00
0034	4072000000-E	903	SUPPORTS, 3-LB STEEL U-CHANNEL	50 LF	7.80	390.00
0035	4116100000-N	904	SIGN ERECTION, RELOCATE TYPE **** (GROUND MOUNTED) (TYPE D)	1 EA	210.00	210.00

Line #	ItemNumber	Sec #	Description	Quantity Unit	Unit Bid Price	Amount Bid
0036	4116100000-N	904	SIGN ERECTION, RELOCATE TYPE **** (GROUND MOUNTED) (TYPE E)	10 EA	120.00	1,200.00
0037	4186000000-N	907	STOCKPILE SUPPORT, U-CHANNEL	5 EA	192.15	960.75
0038	4192000000-N	907	DISPOSAL OF SUPPORT, U-CHANNEL	5 EA	12.00	60.00
0039	4400000000-E	1110	WORK ZONE SIGNS (STATIONARY)	160 SF	8.32	1,331.20
0040	4405000000-E	1110	WORK ZONE SIGNS (PORTABLE)	192 SF	13.20	2,534.40
0041	4415000000-N	1115	FLASHING ARROW BOARD	4 EA	2,880.00	11,520.00
0042	4420000000-N	1120	PORTABLE CHANGEABLE MESSAGE SIGN	4 EA	8,064.00	32,256.00
0043	4430000000-N	1130	DRUMS	150 EA	53.80	8,070.00
0044	4455000000-N	1150	FLAGGER	40 DAY	1,020.00	40,800.00
0045	4480000000-N	1165	TMA	2 EA	10,800.00	21,600.00
0046	4507000000-E	1170	WATER FILLED BARRIER	200 LF	19.20	3,840.00
0047	4516000000-N	1180	SKINNY DRUM	100 EA	47.39	4,739.00
0048	4695000000-E	1205	THERMOPLASTIC PAVEMENT MARKING LINES (8", 90 MILS)	1,000 LF	1.80	1,800.00
0049	4720000000-E	1205	THERMOPLASTIC PAVEMENT MARKING CHARACTER (90 MILS)	8 EA	240.00	1,920.00
0050	4725000000-E	1205	THERMOPLASTIC PAVEMENT MARKING SYMBOL (90 MILS)	29 EA	120.00	3,480.00
0051	4810000000-E	1205	PAINT PAVEMENT MARKING LINES (4")	3,110 LF	0.72	2,239.20
0052	4870000000-E	1205	REMOVAL OF PAVEMENT MARKING LINES (24")	15 LF	7.20	108.00
0053	4890000000-E	SP	GENERIC PAVEMENT MARKING ITEM 4" 60 MIL YELLOW THERMOPLASTIC PAVEMENT MARKING LINES	5,800 LF	1.80	10,440.00

## Contract Item Sheets For DN00765

Line #	ItemNumber	Sec #	Description	Quantity Unit	Unit Bid Price	Amount Bid
0054	4891000000-E	1205	GENERIC PAVEMENT MARKING ITEM 24" 90 MIL WHTIE THERMOPLASTIC PAVEMENT MARKING LINES	72 LF	6.00	432.00
0055	4895000000-N	SP	GENERIC PAVEMENT MARKING ITEM NON-CAST IRON SNOWPLOWABLE PAV EMENT MARKERS	48 EA	96.00	4,608.00
0056	6000000000-E	1605	TEMPORARY SILT FENCE	820 LF	10.80	8,856.00
0057	6006000000-E	1610	STONE FOR EROSION CONTROL, CLASS A	30 TON	75.00	2,250.00
0058	6009000000-E	1610	STONE FOR EROSION CONTROL, CLASS B	20 TON	75.00	1,500.00
0059	6012000000-E	1610	SEDIMENT CONTROL STONE	65 TON	75.00	4,875.00
0060	6015000000-E	1615	TEMPORARY MULCHING	2.5 ACR	2,736.00	6,840.00
0061	6018000000-E	1620	SEED FOR TEMPORARY SEEDING	300 LB	3.60	1,080.00
0062	6021000000-E	1620	FERTILIZER FOR TEMPORARY SEED- ING	2 TON	3,000.00	6,000.00
0063	6024000000-E	1622	TEMPORARY SLOPE DRAINS	200 LF	36.68	7,336.00
0064	6029000000-E	SP	SAFETY FENCE	800 LF	4.80	3,840.00
0065	6030000000-E	1630	SILT EXCAVATION	50 CY	30.00	1,500.00
0066	6036000000-E	1631	MATTING FOR EROSION CONTROL	10,000 SY	2.40	24,000.00
0067	6042000000-E	1632	1/4" HARDWARE CLOTH	240 LF	6.00	1,440.00
0068	6071012000-E	SP	COIR FIBER WATTLE	260 LF	14.40	3,744.00
0069	6071020000-E	SP	POLYACRYLAMIDE (PAM)	12 LB	20.00	240.00
0070	6084000000-E	1660	SEEDING & MULCHING	3 ACR	5,760.00	17,280.00
0071	6090000000-E	1661	SEED FOR REPAIR SEEDING	50 LB	3.60	180.00
0072	6093000000-E	1661	FERTILIZER FOR REPAIR SEEDING	0.25 TON	3,000.00	750.00

Contract Item Sheets For DN00765

Line #	ItemNumber	Sec #	Description	Quantity Unit	Unit Bid Price	Amount Bid
0073	6096000000-E	1662	SEED FOR SUPPLEMENTAL SEEDING	75 LB	3.60	270.00
0074	6108000000-E	1665	FERTILIZER TOPDRESSING	2.25 TON	3,000.00	6,750.00
0075	6114500000-N	1667	SPECIALIZED HAND MOWING	10 MHR	150.00	1,500.00
0076	6117000000-N	SP	RESPONSE FOR EROSION CONTROL	8 EA	720.00	5,760.00
0077	6117500000-N	SP	CONCRETE WASHOUT STRUCTURE	2 EA	650.00	1,300.00
0078	6132000000-N	SP	GENERIC EROSION CONTROL ITEM FABRIC INSERT INLET PROTECTION DEVICE	1 EA	400.00	400.00
0079	6132000000-N	SP	GENERIC EROSION CONTROL ITEM FABRIC INSERT INLET PROTECTION DEVICE CLEAN OUT	1 EA	250.00	250.00
0080	7060000000-E	1705	SIGNAL CABLE	3,500 LF	3.60	12,600.00
0081	7120000000-E	1705	VEHICLE SIGNAL HEAD (12", 3 SECTION)	12 EA	1,020.00	12,240.00
0082	7264000000-E	1710	MESSENGER CABLE (3/8")	1,200 LF	6.00	7,200.00
0083	7300000000-E	1715	UNPAVED TRENCHING (*****)(1) (2")	3,600 LF	12.89	46,404.00
0084	7300000000-E	1715	UNPAVED TRENCHING (*****)(2) (2")	350 LF	21.60	7,560.00
0085	7300000000-E	1715	UNPAVED TRENCHING (*****)(4) (2")	20 LF	60.00	1,200.00
0086	7324000000-N	1716	JUNCTION BOX (STANDARD SIZE)	9 EA	660.00	5,940.00
0087	7444000000-E	1725	INDUCTIVE LOOP SAWCUT	1,100 LF	10.50	11,550.00
0088	7456000000-E	1726	LEAD-IN CABLE (*****)(14-2)	9,000 LF	2.10	18,900.00
0089	7576000000-N	SP	METAL STRAIN SIGNAL POLE	4 EA	16,800.00	67,200.00
0090	7613000000-N	SP	SOIL TEST	4 EA	1,290.00	5,160.00

Contract Item Sheets For DN00765

Line #	ItemNumber	Sec #	Description	Quantity Unit	Unit Bid Price	Amount Bid
0091	7614100000-E	SP	DRILLED PIER FOUNDATION	24 CY	1,860.00	44,640.00
0092	7630000000-N	SP	METAL STRAIN POLE DESIGN	4 EA	300.00	1,200.00
0093	7636000000-N	1745	SIGN FOR SIGNALS	2 EA	600.00	1,200.00
0094	7980000000-N	SP	GENERIC SIGNAL ITEM MICROWAVE VEHICLE DETECTION SY STEM - MULTIPLE ZONES	3 EA	21,600.00	64,800.00
0095	7360000000-N	1720	WOOD POLE	4 EA	930.00	3,720.00
0096	7372000000-N	1721	GUY ASSEMBLY	8 EA	720.00	5,760.00
0097	7408000000-E	1722	1" RISER WITH WEATHERHEAD	1 EA	480.00	480.00
0098	7420000000-E	1722	2" RISER WITH WEATHERHEAD	5 EA	930.00	4,650.00
0099	7575180000-N	1735	CABLE TRANSFER	8 EA	240.00	1,920.00
0100	7684000000-N	1750	SIGNAL CABINET FOUNDATION	1 EA	3,600.00	3,600.00
0101	7756000000-N	1751	CONTROLLER WITH CABINET (TYPE 2070L, BASE MOUNTED)	1 EA	19,200.00	19,200.00
0102	7780000000-N	1751	DETECTOR CARD (TYPE 2070L)	5 EA	156.00	780.00
0103	7901000000-N	1753	CABINET BASE EXTENDER	1 EA	420.00	420.00
0104	7948000000-N	1757	TRAFFIC SIGNAL REMOVAL	2 EA	2,400.00	4,800.00

TOTAL AMOUNT OF BID FOR ENTIRE PROJECT

\$1,626,711.19

**Execution of Contract**

**Contract No: DN00765**

**County: Macon**

ACCEPTED BY THE DEPARTMENT

DocuSigned by:

*Jeffrey E. Alsopangh*

160F4BFF87884E1

**Proposals Engineer**

04/19/2022

Date

EXECUTION OF CONTRACT AND BONDS  
APPROVED AS TO FORM:

DocuSigned by:

*Wanda Austin*

B88118F1E31C453

**Division Engineer**

04/19/2022

Date

Signature Sheet (Bid) - ACCEPTANCE SHEET

Contract No.  
County

**DN00765**

Macon

Rev 5-17-11

**CONTRACT PAYMENT BOND**

Date of Payment Bond Execution 3/16/2022

Name of Principal Contractor Bryson Enterprises LTD dba Bryson Grading & Paving

Name of Surety: Contractors Bonding and Insurance Company

Name of Contracting Body: North Carolina Department of Transportation

Raleigh, North Carolina

Amount of Bond: \$1,626,711.19

Contract ID No.: DN00765

County Name: Macon

KNOW ALL MEN BY THESE PRESENTS, That we, the PRINCIPAL CONTRACTOR (hereafter, PRINCIPAL) and SURETY above named, are held and firmly bound unto the above named Contracting Body, hereinafter called the Contracting Body, in the penal sum of the amount stated above for the payment of which sum well and truly to be made, we bind ourselves, our heirs, executors, administrators, and successors, jointly and severally, firmly by these presents.

THE CONDITION OF THIS OBLIGATION IS SUCH, that whereas the principal entered into a certain contract with the Contracting Body, numbered as shown above and hereto attached:

NOW THEREFORE, if the principal shall promptly make payment to all persons supplying labor and material in the prosecution of the work provided for in said contract, and any and all duly authorized modifications of said contract that may hereafter be made, notice of which modifications to the surety being hereby waived, then this obligation to be void; otherwise to remain in full force and virtue.

IN WITNESS WHEREOF, the above-bound parties have executed this instrument under their several seals on the date indicated above, the name and corporate seal of each corporate party being hereto affixed and these presents duly signed by its undersigned representative, pursuant to authority of its governing body.

Contract No.  
County

**DN00765**

Macon

Rev 5-17-11

**CONTRACT PAYMENT BOND**

*Affix Seal of Surety Company*

Contractors Bonding and Insurance Company

Print or type Surety Company Name



By **Jessica F. Jenkins**

Print, stamp or type name of Attorney-in-Fact

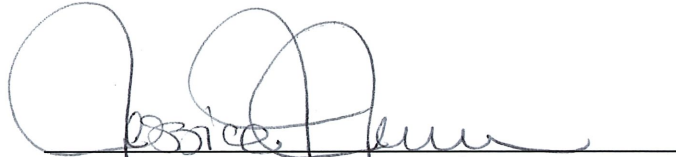
  
Signature of Attorney-in-Fact

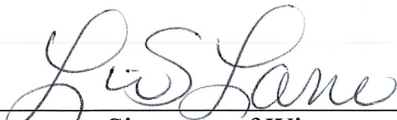
  
Signature of Witness

**Lori Lane**

Print or type Signer's name

472 Carolina Way Highlands, NC 28741

Address of Attorney-in-Fact



Contract No.  
County

DN00765

Macon

Rev 5-17-11

**CONTRACT PAYMENT BOND**

**CORPORATION**

SIGNATURE OF CONTRACTOR (Principal)

**Bryson Enterprises LTD dba Bryson Grading & Paving**

Full name of Corporation

**PO Box 1691 Highlands, NC 28741**

Address as prequalified

By   
Signature of ~~President~~ Vice President ~~Assistant Vice President~~  
*Select appropriate title*

Ryan Bryson  
Print or type Signer's name

*Affix Corporate Seal*

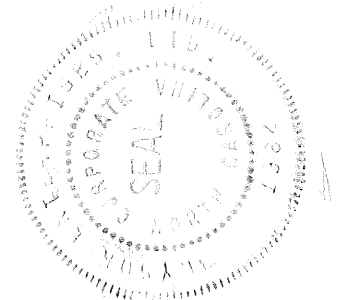

Attest   
Signature of Secretary ~~Assistant Secretary~~  
*Select appropriate title*

Becki Bryson  
Print or type Signer's name

Contract No.  
County

DN00765  
Macon

Rev 5-17-11

**CONTRACT PAYMENT BOND**

Attach certified copy of Power of Attorney to this sheet

# POWER OF ATTORNEY

RETURN TO:

NORTH CAROLINA  
COUNTY OF Macon

TIP NUMBER: HA-0004  
WBS ELEMENT: 49761.3.1

## KNOW ALL MEN BY THESE PRESENTS:

That we (I) the undersigned, do hereby make, constitute, and appoint Contractors Bonding and Insurance Company our true and lawful Attorney in Fact and do delegate said attorney the powers to do and perform in our name, place and stead, the following matters and things:

1. To negotiate with the Department of Transportation of the State of North Carolina, its agents and employees, for the settlement of any and all right of way claims whatsoever which we may have against the said Department of Transportation by reason of damages sustained by our property, real, personal, or mixed, in the construction of TIP Project DN00765, Macon County.
2. To execute and deliver rights of entry to the said Department of Transportation prior to the institution or completion of negotiations for settlement of said claims.
3. To sell, bargain and convey property, and any interests therein, or a portion thereof, sought to be acquired by the said Department of Transportation under TIP Project DN00765; and to execute and deliver such options, leases, releases, warranty deeds, quitclaim deeds, deeds of easement, right of way agreements, and any other instrument as may be necessary to effectuate the sale and conveyance of said property to the Department of Transportation.
4. To execute and deliver such options, leases, releases, warranty deeds, quitclaim deeds, deeds of easement, right of way agreements, and any other instrument as may be necessary to grant to the Department of Transportation the right to acquire and procure materials from our said property; and materials is defined to include but is not limited to gravel, gravel beds or bars, sand, sand beds or bars, rock, stone, boulders, quarries or quarry beds, lime, earth, mineral deposits or formations, and timber.
5. To receive and receipt for all moneys paid by the said Department of Transportation in settlement of any claims that we have or may have against the Department of Transportation by reason of the construction of said TIP Project DN00765, paid in consideration of the conveyance of any of our property or interests therein; and payment of said sums to our attorney in fact shall be deemed to be, in all respects, the same as payment to us.

And we do hereby grant unto our said Attorney in Fact any and all other powers necessary to do and perform every act or thing whatsoever requisite and necessary to be done in handling and accomplishing the aforesaid matters.

And we do hereby ratify and confirm all things so done by our said Attorney in Fact, within the scope and authority herein given him or her, as fully as if by us personally done and performed.



Contract No.  
County

**DN00765**

Macon

Rev 5-17-11

**CONTRACT PERFORMANCE BOND**

Date of Performance Bond Execution: 3/16/2022

Name of Principal Contractor: Bryson Enterprises LTD dba Bryson Grading & Paving

Name of Surety: Contractors Bonding and Insurance Company

Name of Contracting Body: North Carolina Department of Transportation  
Raleigh, North Carolina

Amount of Bond: \$1,626,711.19

Contract ID No.: DN00765

County Name: Macon

KNOW ALL MEN BY THESE PRESENTS, That we, the PRINCIPAL CONTRACTOR (hereafter, PRINCIPAL) and SURETY above named, are held and firmly bound unto the above named Contracting Body, hereinafter called the Contracting Body, in the penal sum of the amount stated above for the payment of which sum well and truly to be made, we bind ourselves, our heirs, executors, administrators, and successors, jointly and severally, firmly by these presents.

THE CONDITION OF THIS OBLIGATION IS SUCH, that whereas the principal entered into a certain contract with the Contracting Body, numbered as shown above and hereto attached:

NOW THEREFORE, if the principal shall well and truly perform and fulfill all the undertakings, covenants, terms, conditions, and agreements of said contract during the original term of said contract and any extensions thereof that may be granted by the Contracting Body, with or without notice to the Surety, and during the life of any guaranty required under the contract, and shall also well and truly perform and fulfill all the undertakings, covenants, terms, conditions, and agreements of any and all duly authorized modifications of said contract that may hereafter be made, notice of which modifications to the surety being hereby waived, then this obligation to be void; otherwise to remain in full force and virtue.

IN WITNESS WHEREOF, the above-bound parties have executed this instrument under their several seals on the date indicated above, the name and corporate seal of each corporate party being hereto affixed and these presents duly signed by its undersigned representative, pursuant to authority of its governing body.

Contract No.  
County

**DN00765**

Macon

Rev 5-17-11

**CONTRACT PERFORMANCE BOND**

*Affix Seal of Surety Company*

Contractors Bonding and Insurance Company

Print or type Surety Company Name



By **Jessica F. Jenkins**

Print, stamp or type name of Attorney-in-Fact

A handwritten signature in black ink, appearing to read "Jessica F. Jenkins", written over a horizontal line.

Signature of Attorney-in-Fact

A handwritten signature in black ink, appearing to read "Lori Lane", written over a horizontal line.

Signature of Witness

**Lori Lane**

Print or type Signer's name

472 Carolina Way Highlands, NC 28741

Address of Attorney-in-Fact

Contract No.  
County

DN00765

Macon

Rev 5-17-11

**CONTRACT PERFORMANCE BOND**

**CORPORATION**

SIGNATURE OF CONTRACTOR (Principal)

**Bryson Enterprises LTD dba Bryson Grading & Paving**

Full name of Corporation

**Po Box 1691 Highlands, NC 28741**

Address as prequalified

By   
Signature of ~~President~~, Vice President, ~~Assistant Vice President~~  
Select appropriate title

Ryan Bryson  
Print or type Signer's name

*Affix Corporate Seal*

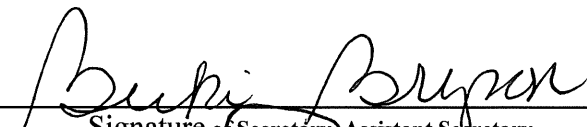
Attest   
Signature of ~~Secretary~~, Assistant Secretary  
Select appropriate title

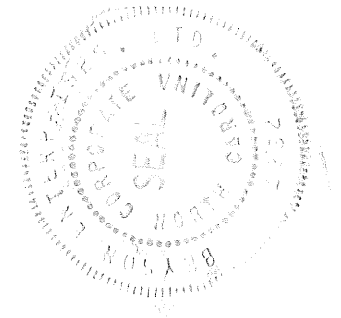

Becki Bryson  
Print or type Signer's name

Contract No.  
County

DN00765  
Macon

Rev 5-17-11

## CONTRACT PERFORMANCE BOND

Attach certified copy of Power of Attorney to this sheet



# POWER OF ATTORNEY

RETURN TO:

NORTH CAROLINA  
COUNTY OF Macon

TIP NUMBER: HA-0004  
WBS ELEMENT: 49761.3.1

## KNOW ALL MEN BY THESE PRESENTS:

That we (I) the undersigned, do hereby make, constitute, and appoint \_\_\_\_\_

Contractors Bonding and Insurance Company

our true and lawful Attorney in Fact and do delegate said attorney the powers to do and perform in our name, place and stead, the following matters and things:

1. To negotiate with the Department of Transportation of the State of North Carolina, its agents and employees, for the settlement of any and all right of way claims whatsoever which we may have against the said Department of Transportation by reason of damages sustained by our property, real, personal, or mixed, in the construction of TIP Project DN00765, Macon County.
2. To execute and deliver rights of entry to the said Department of Transportation prior to the institution or completion of negotiations for settlement of said claims.
3. To sell, bargain and convey property, and any interests therein, or a portion thereof, sought to be acquired by the said Department of Transportation under TIP Project DN00765; and to execute and deliver such options, leases, releases, warranty deeds, quitclaim deeds, deeds of easement, right of way agreements, and any other instrument as may be necessary to effectuate the sale and conveyance of said property to the Department of Transportation.
4. To execute and deliver such options, leases, releases, warranty deeds, quitclaim deeds, deeds of easement, right of way agreements, and any other instrument as may be necessary to grant to the Department of Transportation the right to acquire and procure materials from our said property; and materials is defined to include but is not limited to gravel, gravel beds or bars, sand, sand beds or bars, rock, stone, boulders, quarries or quarry beds, lime, earth, mineral deposits or formations, and timber.
5. To receive and receipt for all moneys paid by the said Department of Transportation in settlement of any claims that we have or may have against the Department of Transportation by reason of the construction of said TIP Project DN00765, paid in consideration of the conveyance of any of our property or interests therein; and payment of said sums to our attorney in fact shall be deemed to be, in all respects, the same as payment to us.

And we do hereby grant unto our said Attorney in Fact any and all other powers necessary to do and perform every act or thing whatsoever requisite and necessary to be done in handling and accomplishing the aforesaid matters.

And we do hereby ratify and confirm all things so done by our said Attorney in Fact, within the scope and authority herein given him or her, as fully as if by us personally done and performed.

IN WITNESS WHEREOF, we have hereunto set our hands and seals (or if corporate, has caused the instrument to be signed in its corporate name by its duly authorized officers and its seal to be hereunto affixed by authority of its Board of Directors) the day and year first above written.

\_\_\_\_\_ (SEAL) \_\_\_\_\_ (SEAL)

Bryson Enterprises LTD

BY: *Ryan Bryson*  
(Vice President)

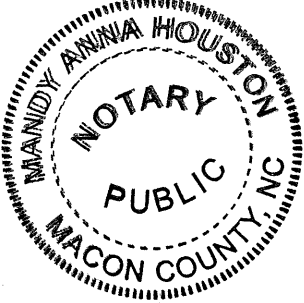

 (Official Seal)	North Carolina, <u>Macon</u> County I, <u>Mandy Anna Houston</u> , a Notary Public for <u>Macon</u> County, North Carolina, do hereby certify that <u>Ryan Bryson</u> personally appeared before me this day and acknowledged the due execution of the foregoing instrument. Witness my hand and official seal this the <u>1</u> day of April , 20 <u>22</u> . <u>Mandy Anna Houston</u> Notary Public My commission expires: <u>4/17/26</u>
	North Carolina, <u>Macon</u> County I, _____, a Notary Public for _____ County, North Carolina, do hereby certify that _____ personally came before me this day and acknowledged that he/she is president of _____, a corporation, and that he/she, as president, being authorized to do so, executed the foregoing on behalf of the corporation. Witness my hand and official seal this the _____ day of , 20_____. _____ Notary Public My commission expires: _____

